

# **Introduction to Solar System Physics**

**Lecture course by  
scientists from the Max Planck Institute for Solar  
System Research in Katlenburg-Lindau**

**summer semester 2009**

**Seminarraum Astrophysik, Mondays 10:15 - 11:45**

**Slides are found in:  
<http://www.solar-system-school.de/lectures.html>**

# Topics and Lecturers

1.	Overview on the solar system	U. Christensen	20.04.
2.	Planetary atmospheres	D. Titov	04.05.
3.	Small bodies	H. Krüger	11.05.
4.	Planetary magnetospheres	N. Krupp	18.05.
5.	Planetary interiors	U. Christensen	25.05.
6.	Formation of planetary systems	D. Schmitt	08.06.
7.	Solar corona and solar wind	E. Marsch	15.06.
8.	Solar – terrestrial relations	J. Büchner	22.06.
9.	Solar interior and helioseismology	L. Gizon	29.06.
10.	Photosphere and Chromosphere	S. Solanki	06.07.
11.	Solar convection zone and magnetic field	M. Schüssler	13.07.

Credit points (3 ECTS) in the bachelor / master curriculum can be obtained after a written test at the end of the semester.

# 8. Solar-Terrestrial Relations

- **Climate – Weather – Space Weather**
- **From Sun to Earth**
- **Solar wind and magnetosphere**
- **Physics of the magnetosphere**
- **Formation of the ionosphere**
- **Ionospheric currents and Aurorae**
- **Influence on men and satellites in space**
- **Space Weather phenomena Earth**

# The first glimpse

## MONTHLY NOTICES

OF THE

## ROYAL ASTRONOMICAL SOCIETY.

VOL. XX.

Nov. 11, 1859.

No. 1.

It has been very gratifying to me to learn that our friend Mr. Hodgson chanced to be observing the sun at his house at Highgate on the same day, and to hear that he was a witness of what he also considered a very remarkable phenomenon. I have carefully avoided exchanging any information with that gentleman, that any value which the accounts may possess may be increased by their entire independence.

(Mr. Carrington exhibited at the November Meeting of the Society a complete diagram of the disk of the sun at the time, and copies of the photographic records of the variations of the three magnetic elements, as obtained at Kew, and pointed out that a moderate but very marked disturbance took place at about 11<sup>h</sup> 20<sup>m</sup> A.M., Sept. 1st, of short duration; and that towards four hours after midnight there commenced a great magnetic storm, which subsequent accounts established to have been as considerable in the southern as in the northern hemisphere. While the contemporary occurrence may deserve noting, he would not have it supposed that he even leans towards hastily connecting them. "One swallow does not make a summer.")

Introduction to Solar System Physics, SS 2009

*Description of a Singular Appearance seen in the Sun on September 1, 1859.* By R. C. Carrington, Esq.

While engaged in the forenoon of Thursday, Sept. 1, in taking my customary observation of the forms and positions of the solar spots, an appearance was witnessed which I believe to be exceedingly rare. The image of the sun's disk was, as usual with me, projected on to a plate of glass coated with distemper of a pale straw colour, and at a distance and under a power which presented a picture of about 11 inches diameter. I had secured diagrams of all the groups and detached spots, and was engaged at the time in counting from a chronometer and recording the contacts of the spots with the cross-wires used in the observation, when within the area of the great north group (the size of which had previously excited general remark), two patches of intensely bright and white light broke out, in the positions indicated in the appended diagram by the letters A and B, and of the forms of the spaces left white. My

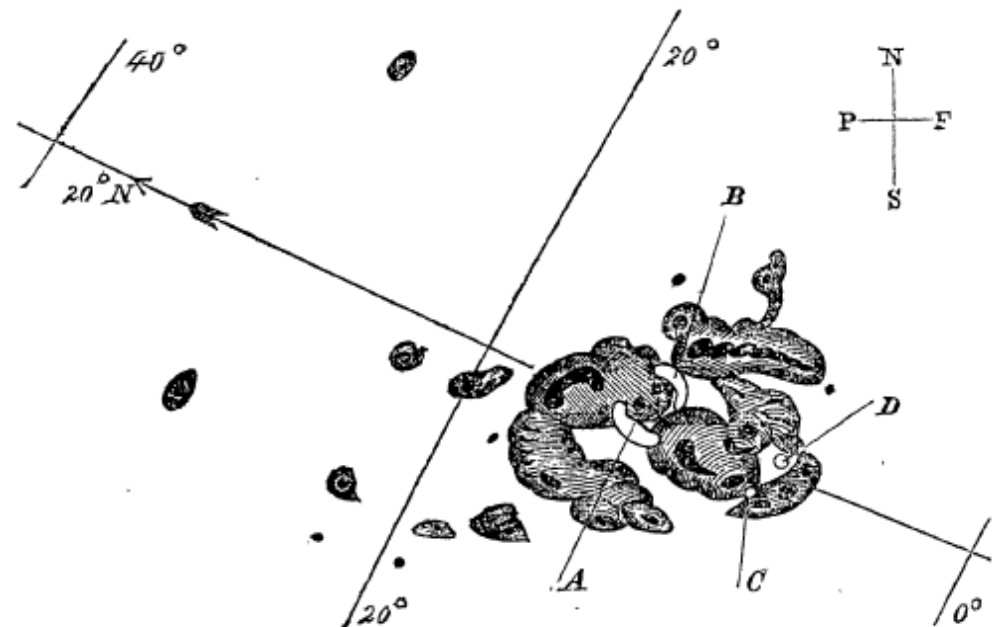

first impression was that by some chance a ray of light had penetrated a hole in the screen attached to the object-glass, by

8. Solar-Terrestrial Relations (Büchner)

# Recent s/c observations of the Sun

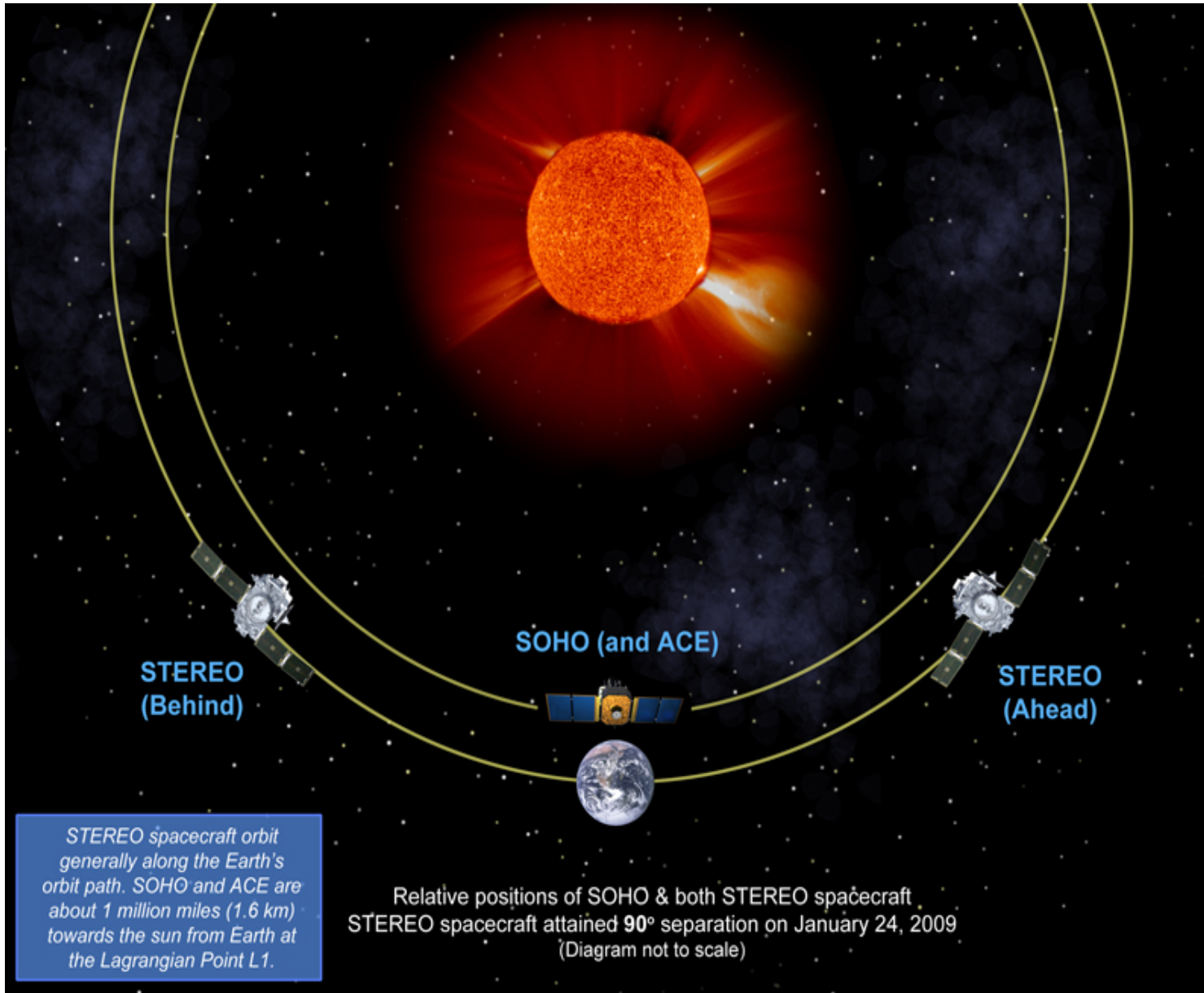

**Missions /  
launch date**

**SOHO /  
Dec 1995**

**ACE /  
Aug 1997**

**HINODE /  
Sep 2006**

**STEREO /  
Oct 2006**

# CME observation by STEREO B / A

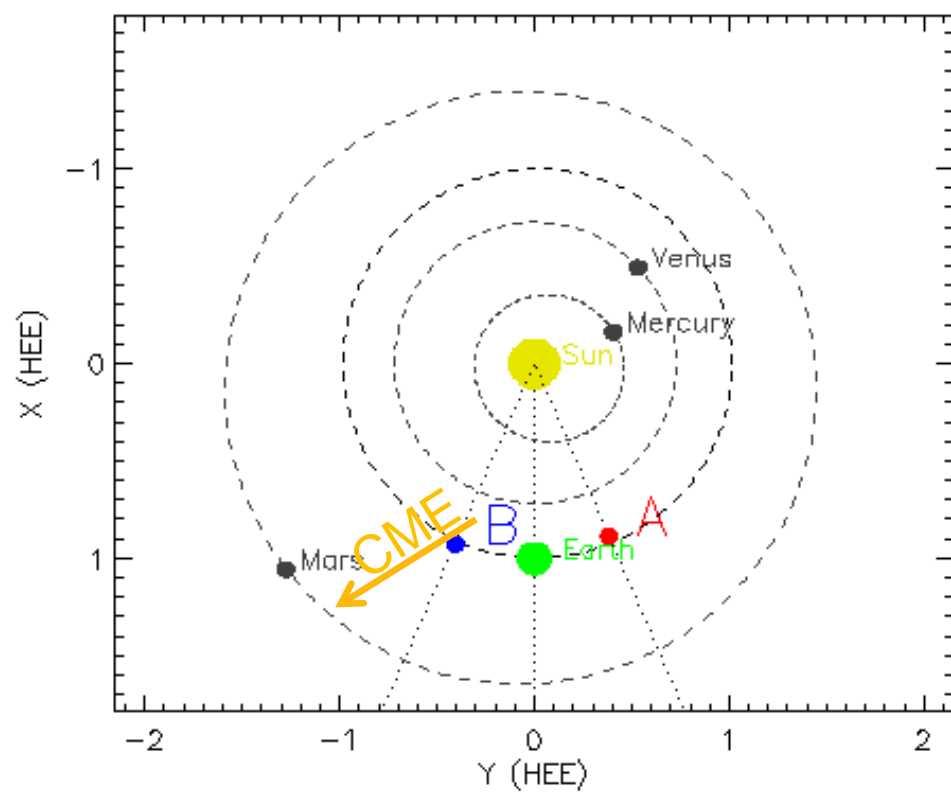

**Situation on  
25.8.2008:  
 $\Delta\phi=47^\circ$ ,  $\Delta t=75s$**

**EUVI A (171 Å): CME first  
7min [Wavelet analysis by  
Stenborg & Vourlidas, NRL]**

# The evolution of the CME launched 25.8.2008 as seen by SECCHI A

HI 1

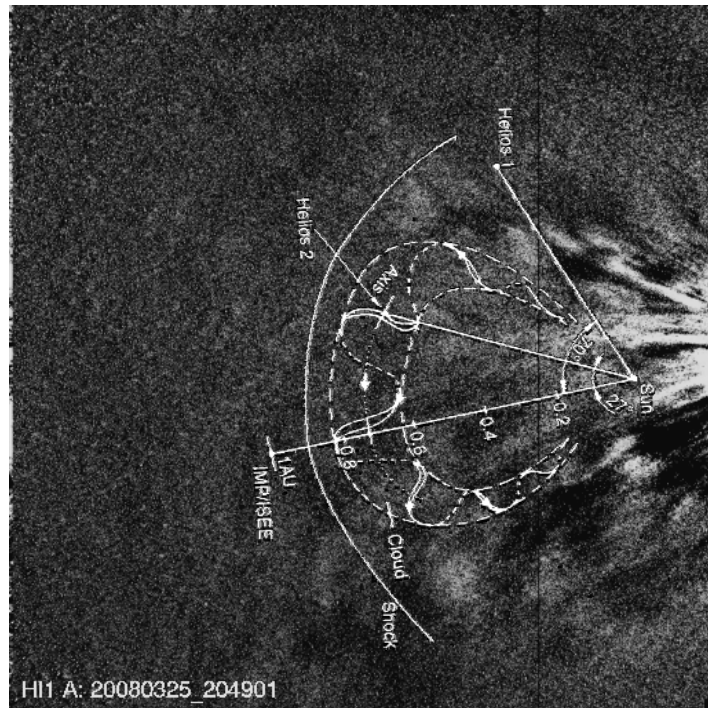

COR 2

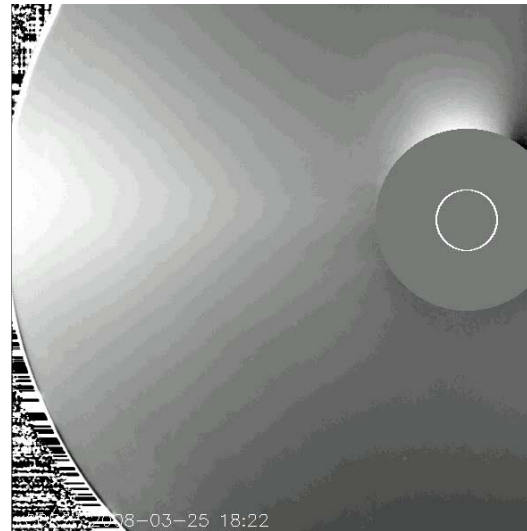

COR 1

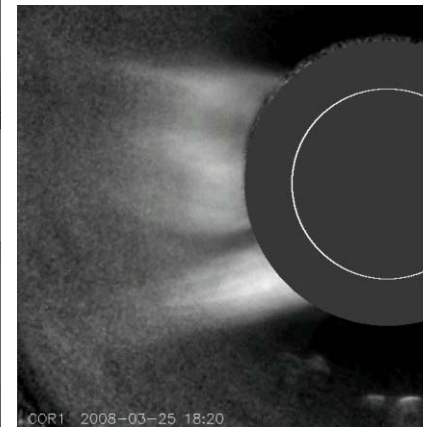

EUVI 171 Å

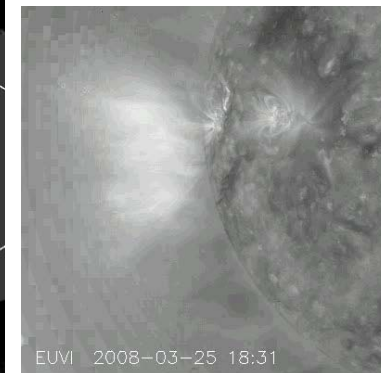

**courtesy: V. Bothmer**

# First successful CME-tracking from Sun to Earth (SECCHI HI, STEREO s/c A)

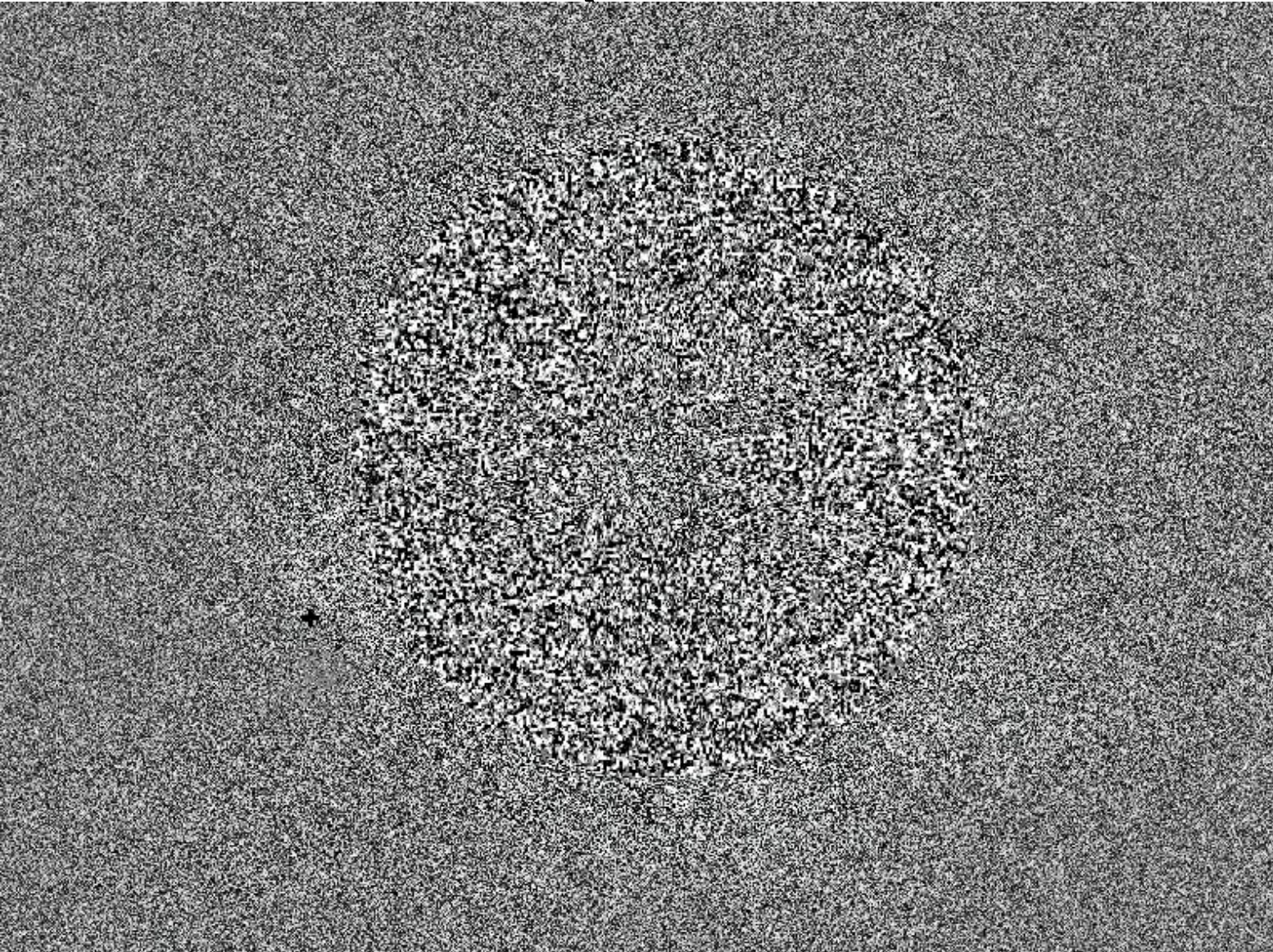

**SECCHI- HI  
(Heliospheric  
Imager,  
Spectral  
range: 400-  
1000 nm)  
observation  
of February 6,  
2008**

**courtesy:  
STEREO –  
SECCHI team**



# Tracing plasma from Sun to Earth

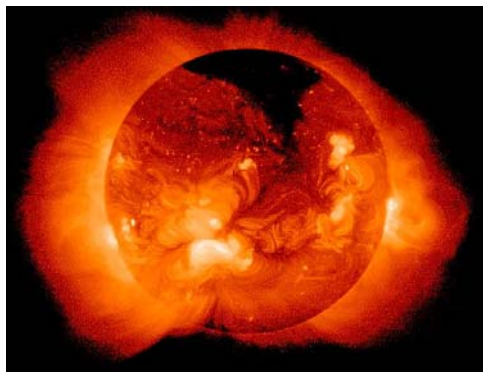
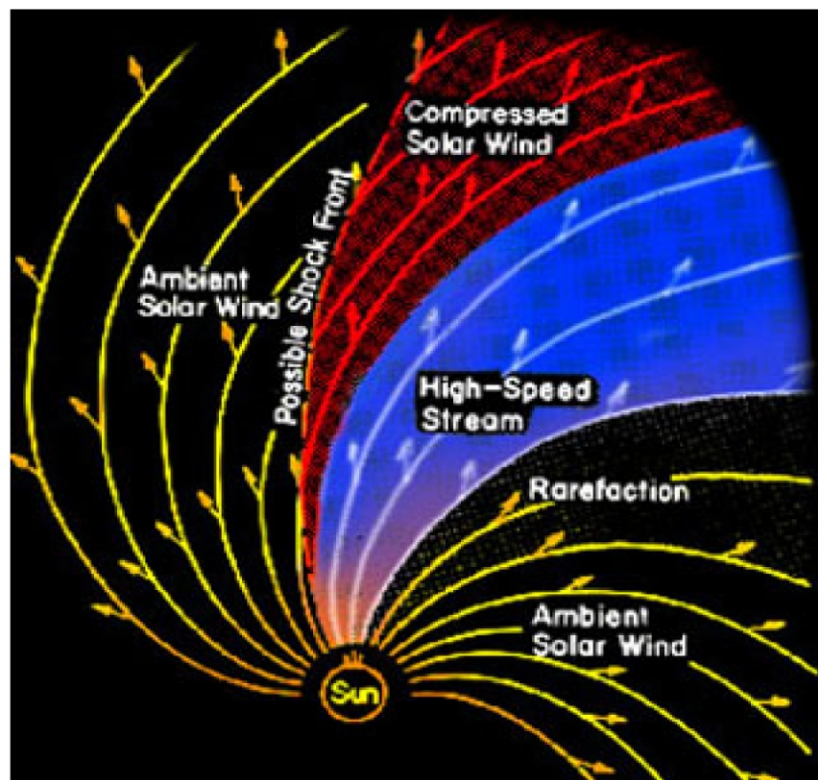

Yohkoh

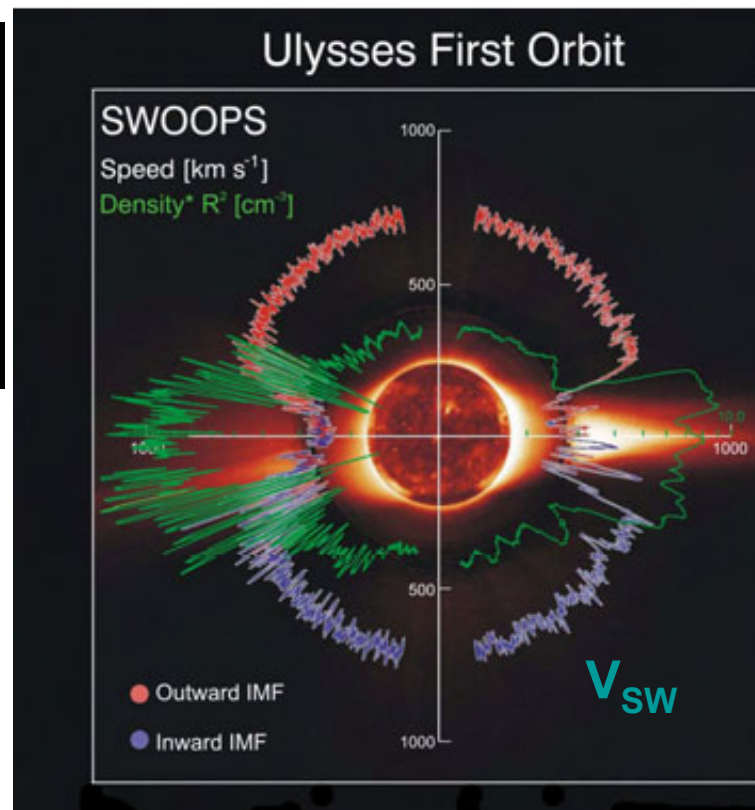

- Slow solar wind: from regions of bright X-ray emissions / low rising solar magnetic field structures ?
- Fast solar wind: from coronal holes / “open” fields
- Interaction of the two: Compressional regions, shocks ...

# Consequences for the Earth

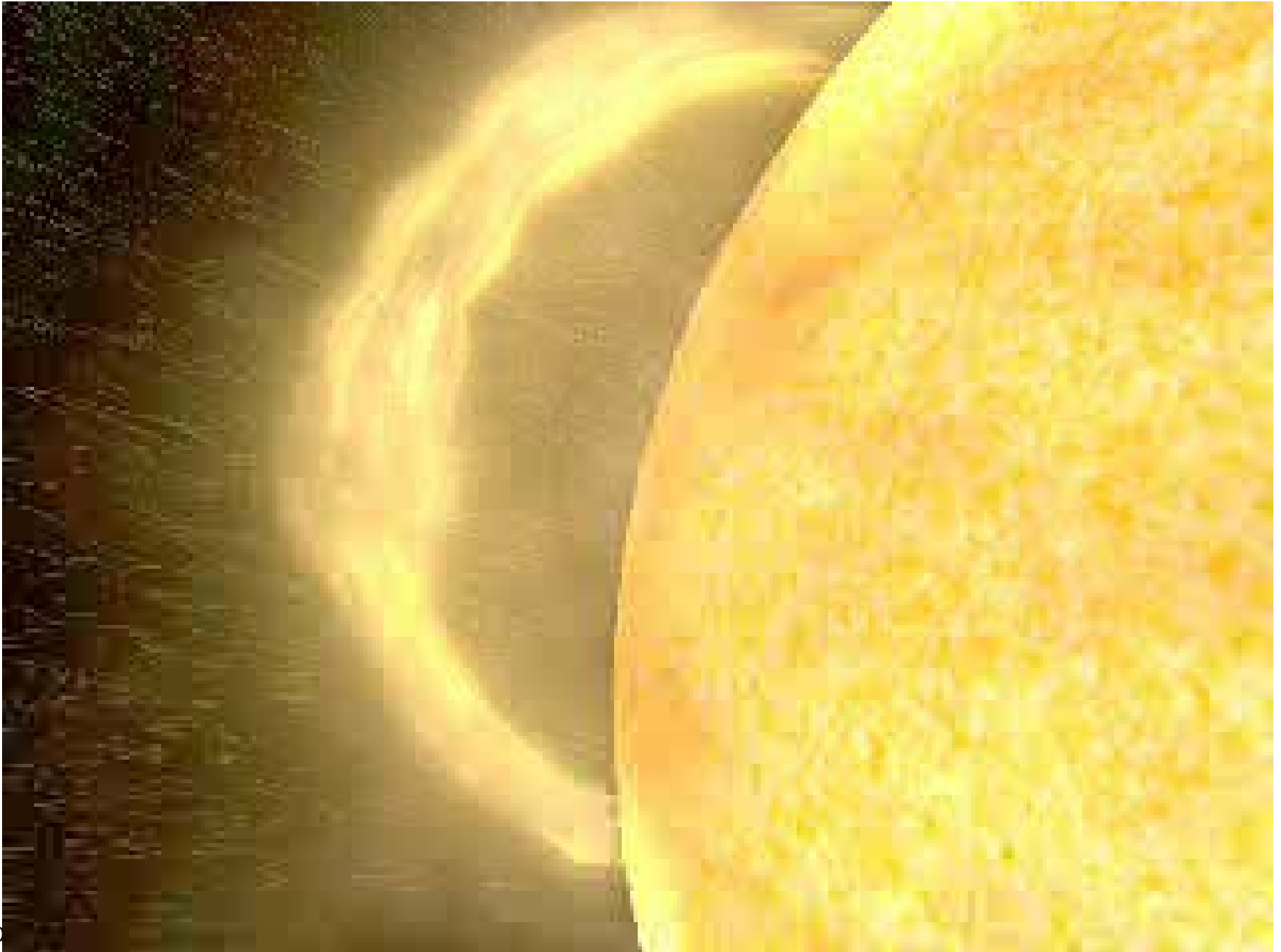

# Magnetic structure near Earth

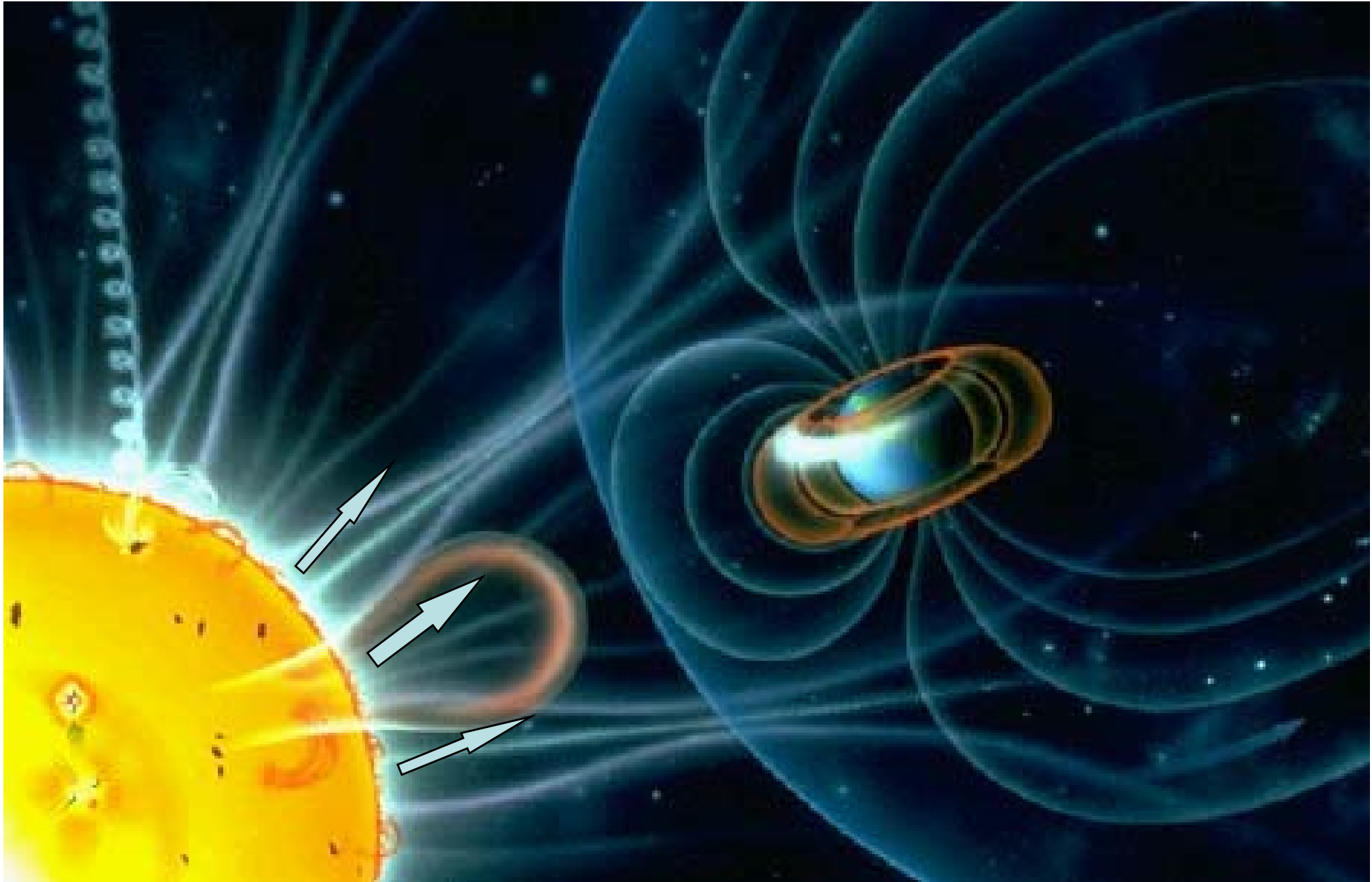

# Bow shock (discovered in the 1960ies)

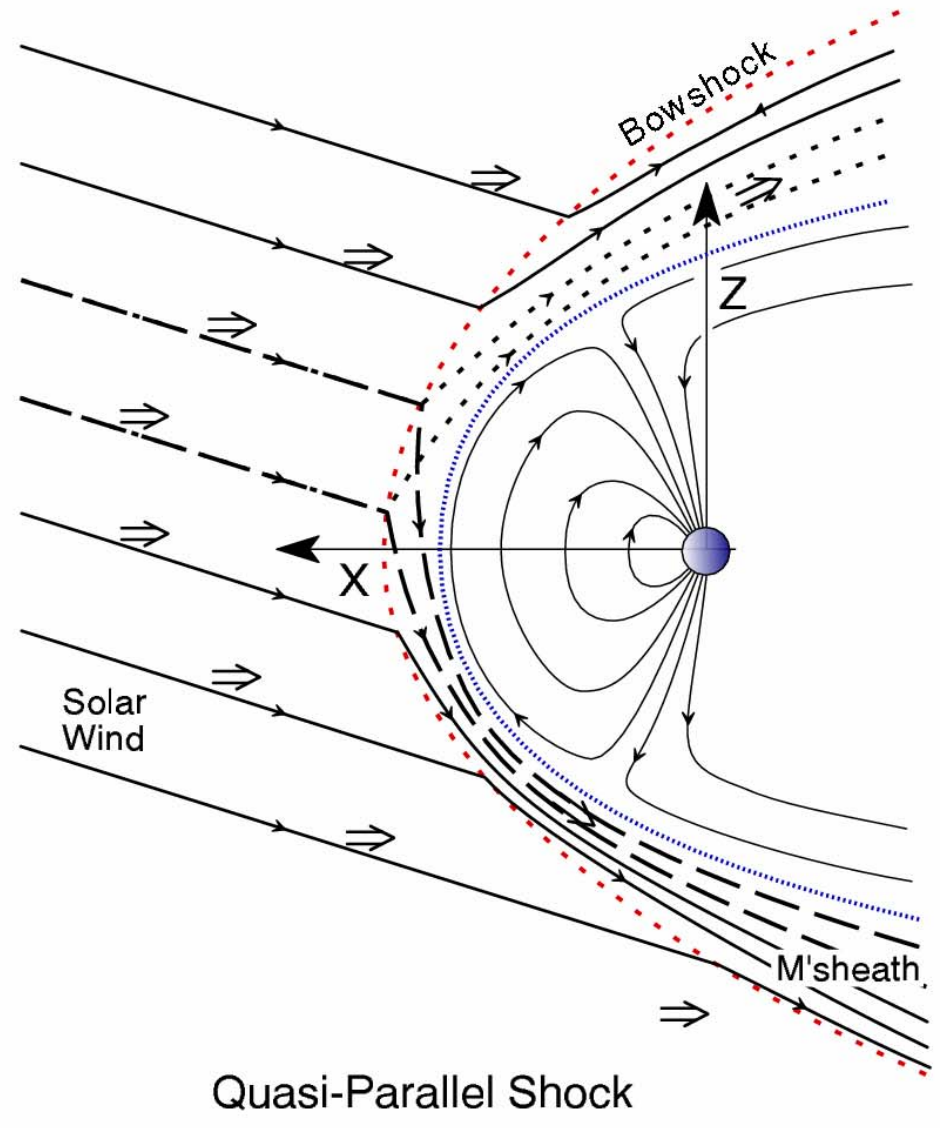
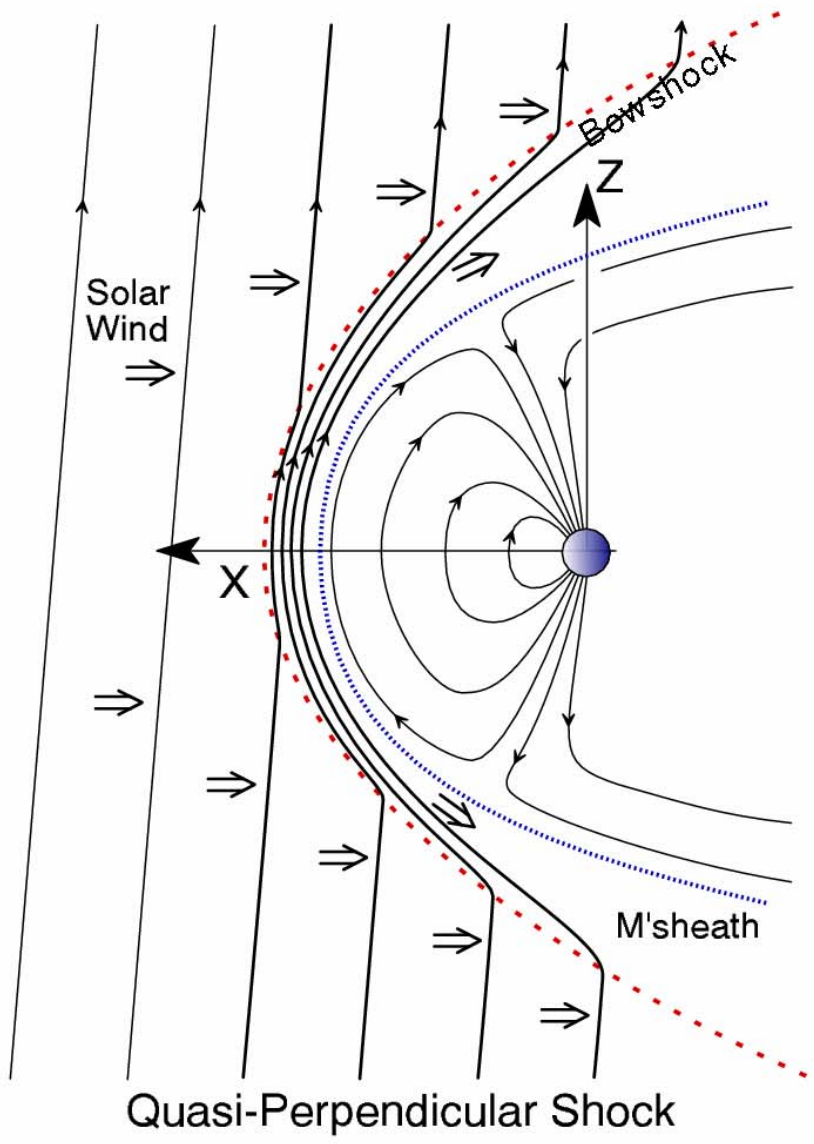

# Partially open magnetosphere (1961)

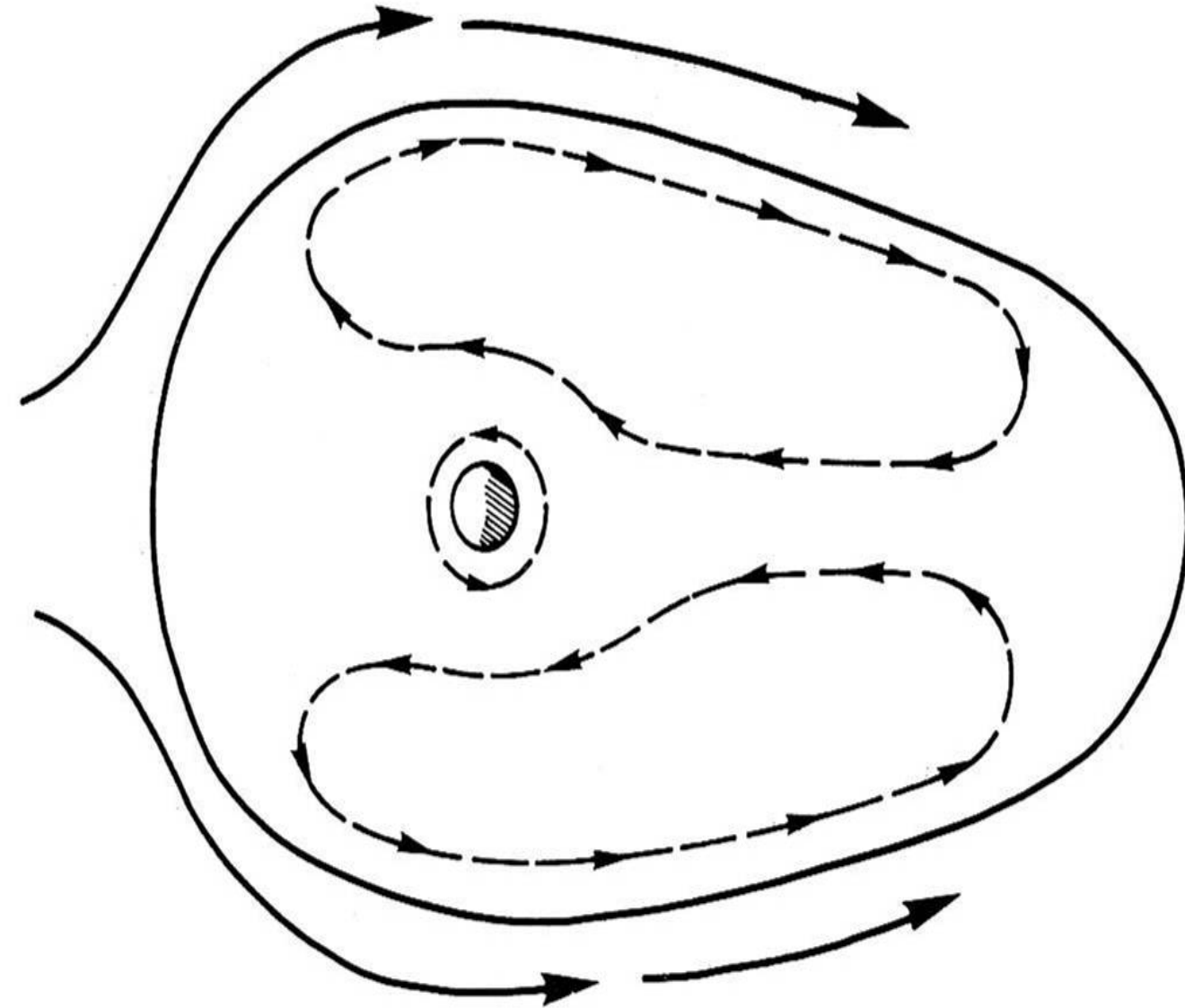

Pattern of the plasma convection driven by **viscous interaction** between the solar wind with a the earth's magnetospheric plasma [Axford and Hines, 1961]

# Open magnetosphere [Dungey, 1961]

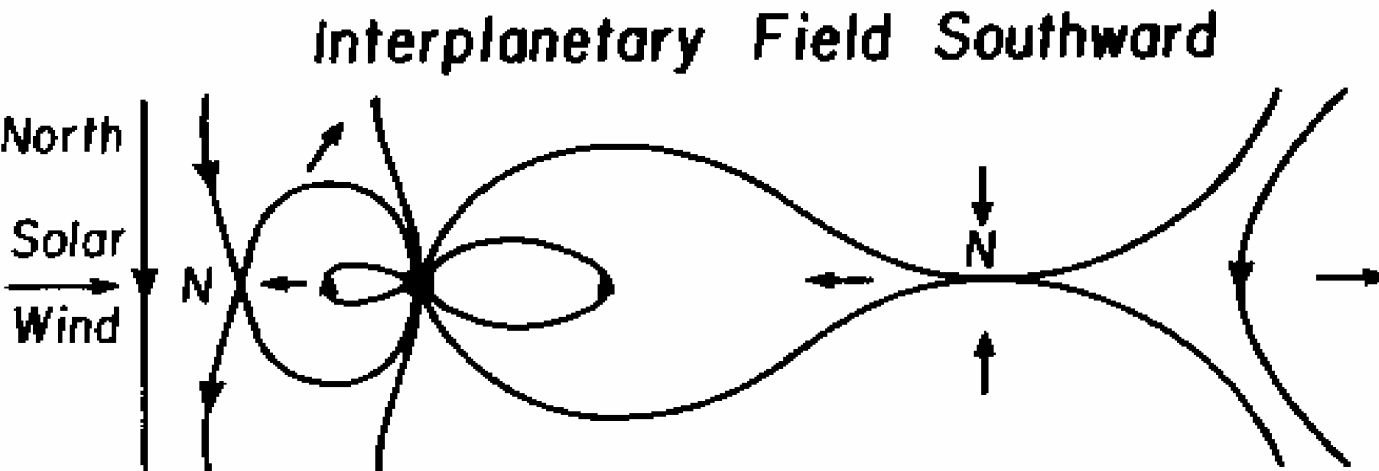

Two basic states:  
(A) Southward  
Interplanetary B-  
field -> strong  
dayside  
**reconnection**  
controls the  
magnetospheric  
convection

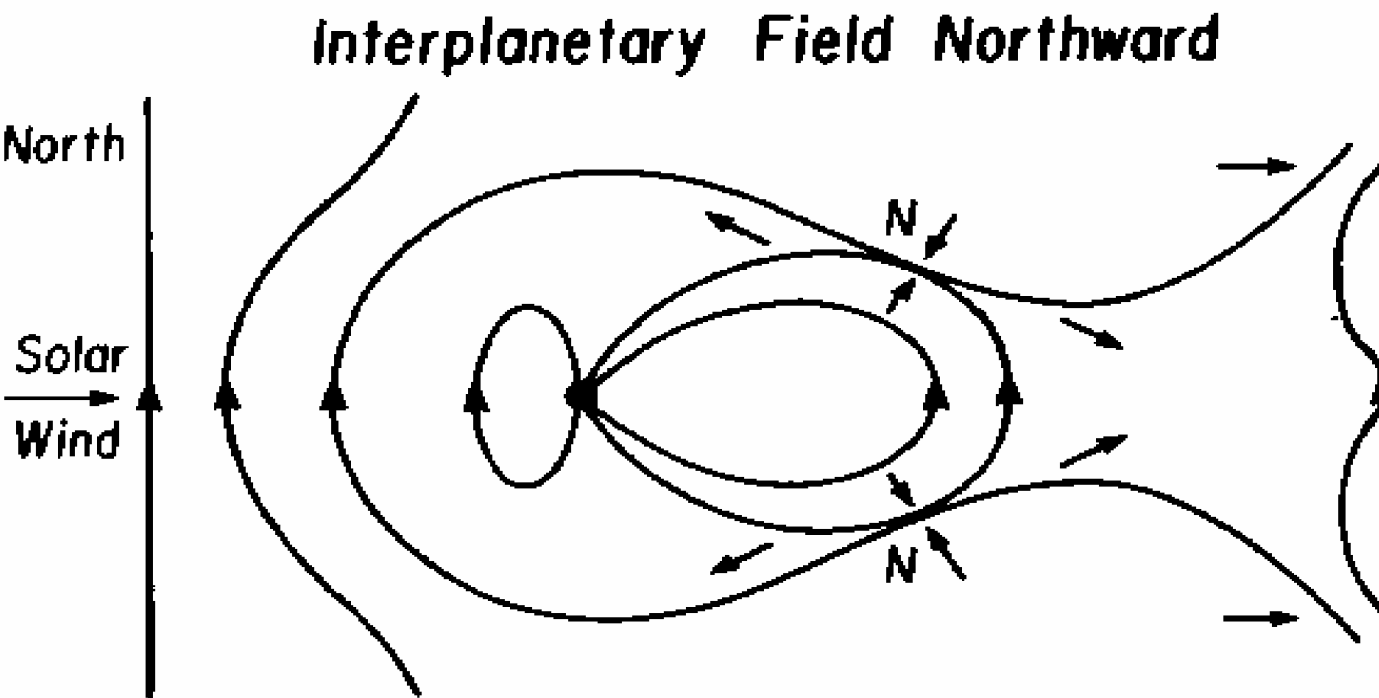

(B) Northward  
Interplanetary B-  
field ->  
**reconnection**  
only behind the  
cusps of the  
magnetosphere,

# Today: Partially open magnetosphere, reconnection and

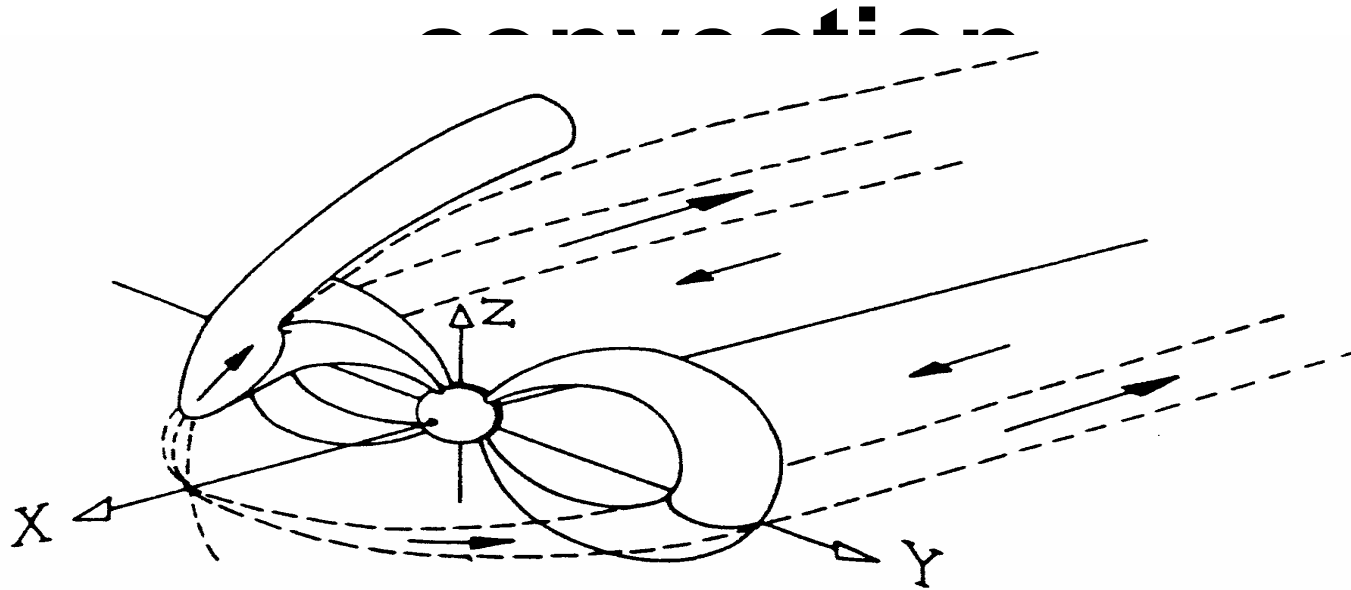

(a)

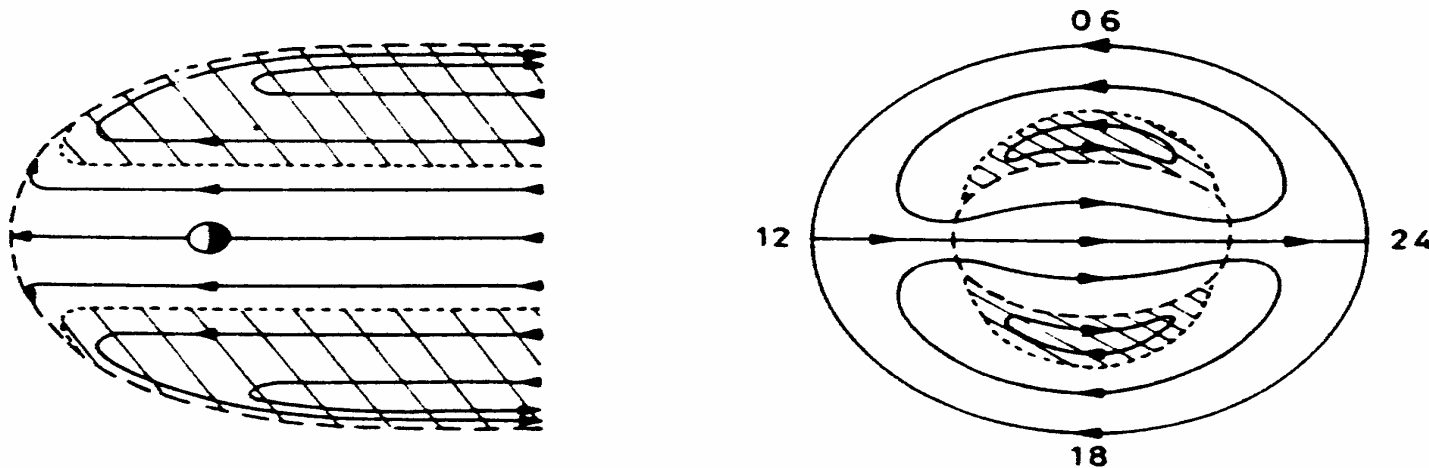

# Magnetopause (Open and closed)

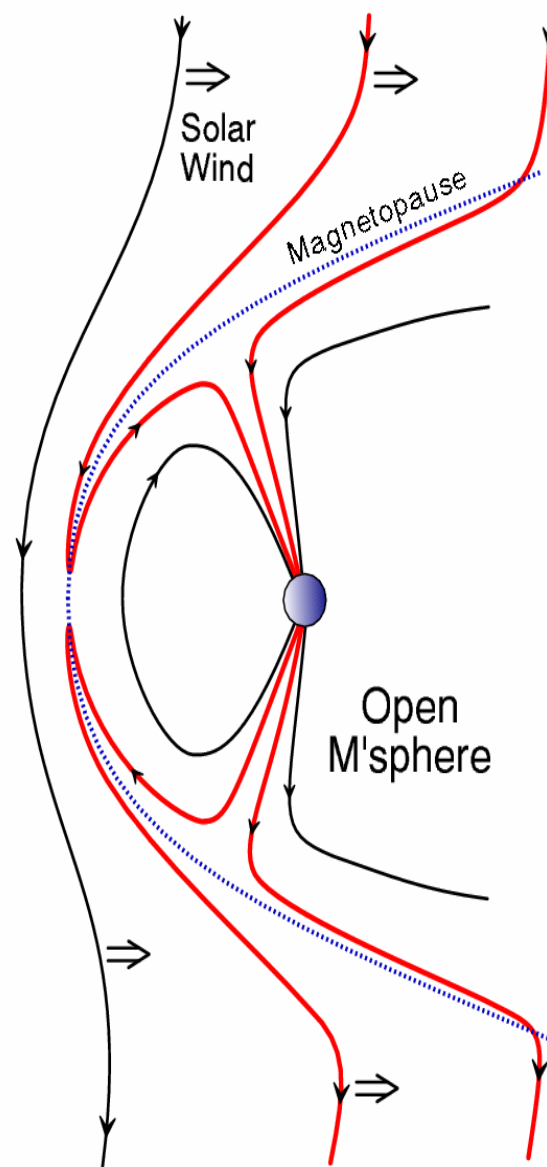
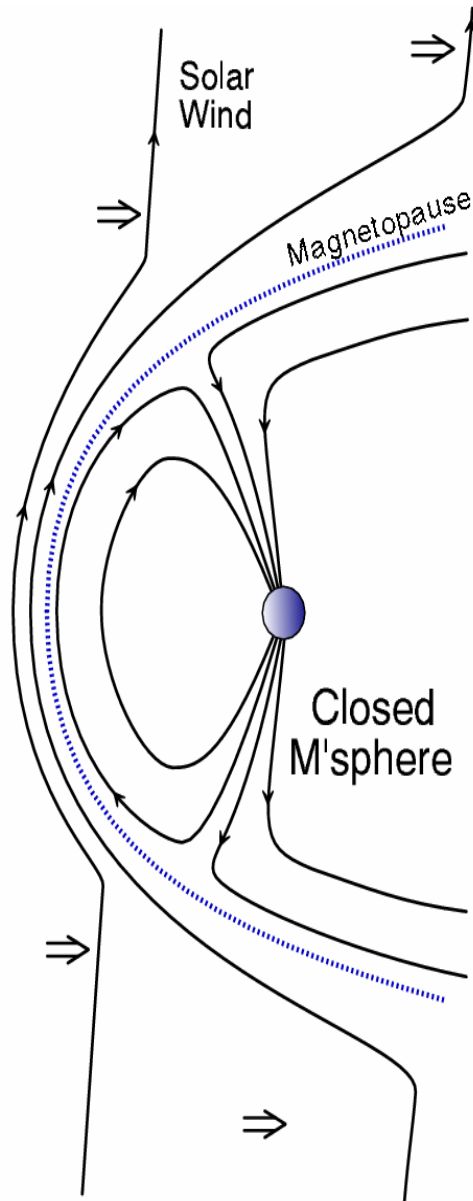

**Left figure:**  
**“Closed”**  
**magnetosphere**  
**inside the blue**  
**dashed**  
**„magnetopause“**

**Right figure:**  
**Red: „Open“**  
**magnetospheric**  
**field lines:**  
**Reconnection**  
**connects**



# Flux-transfer through magnetopause

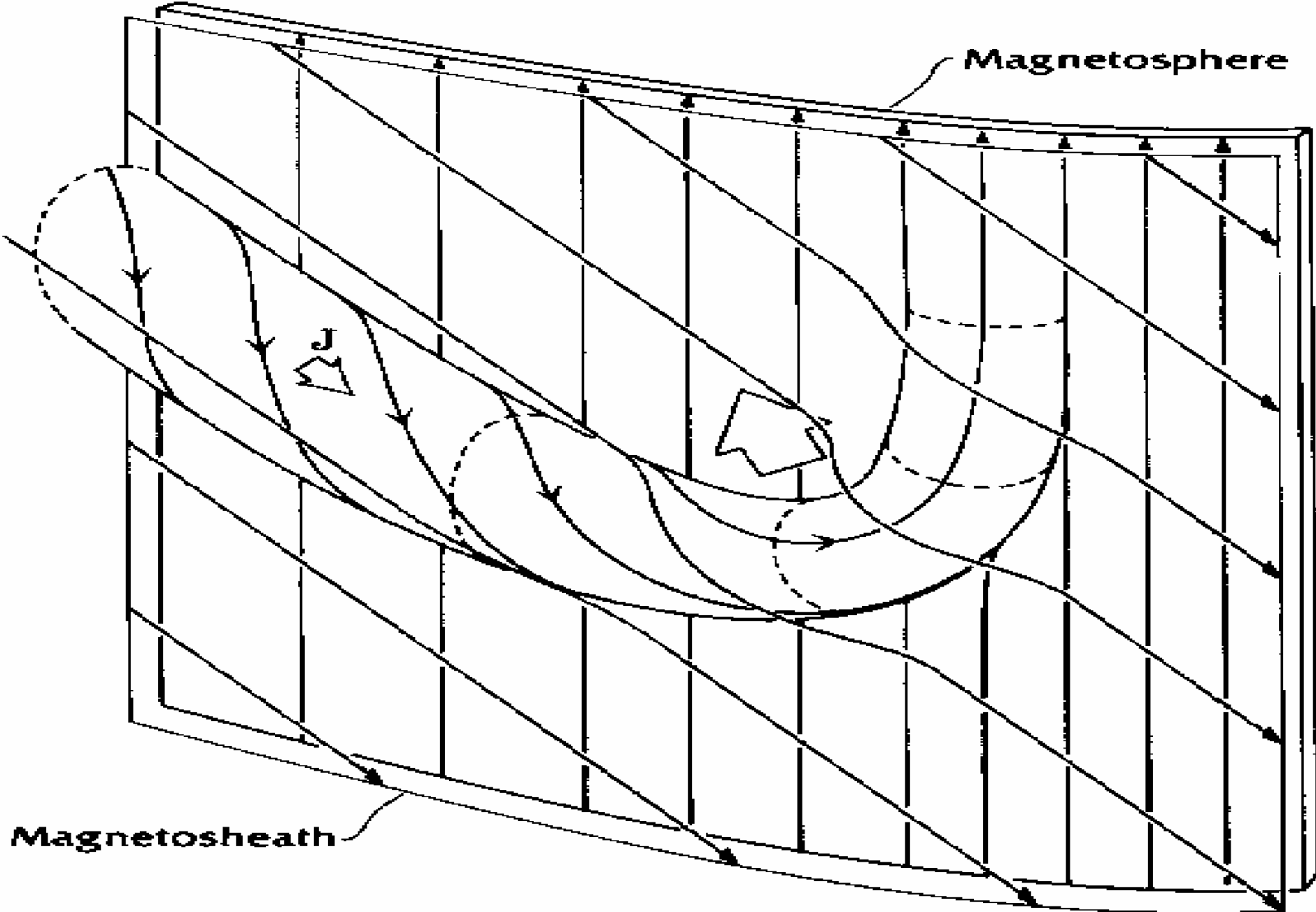

# Magnetospheric current systems

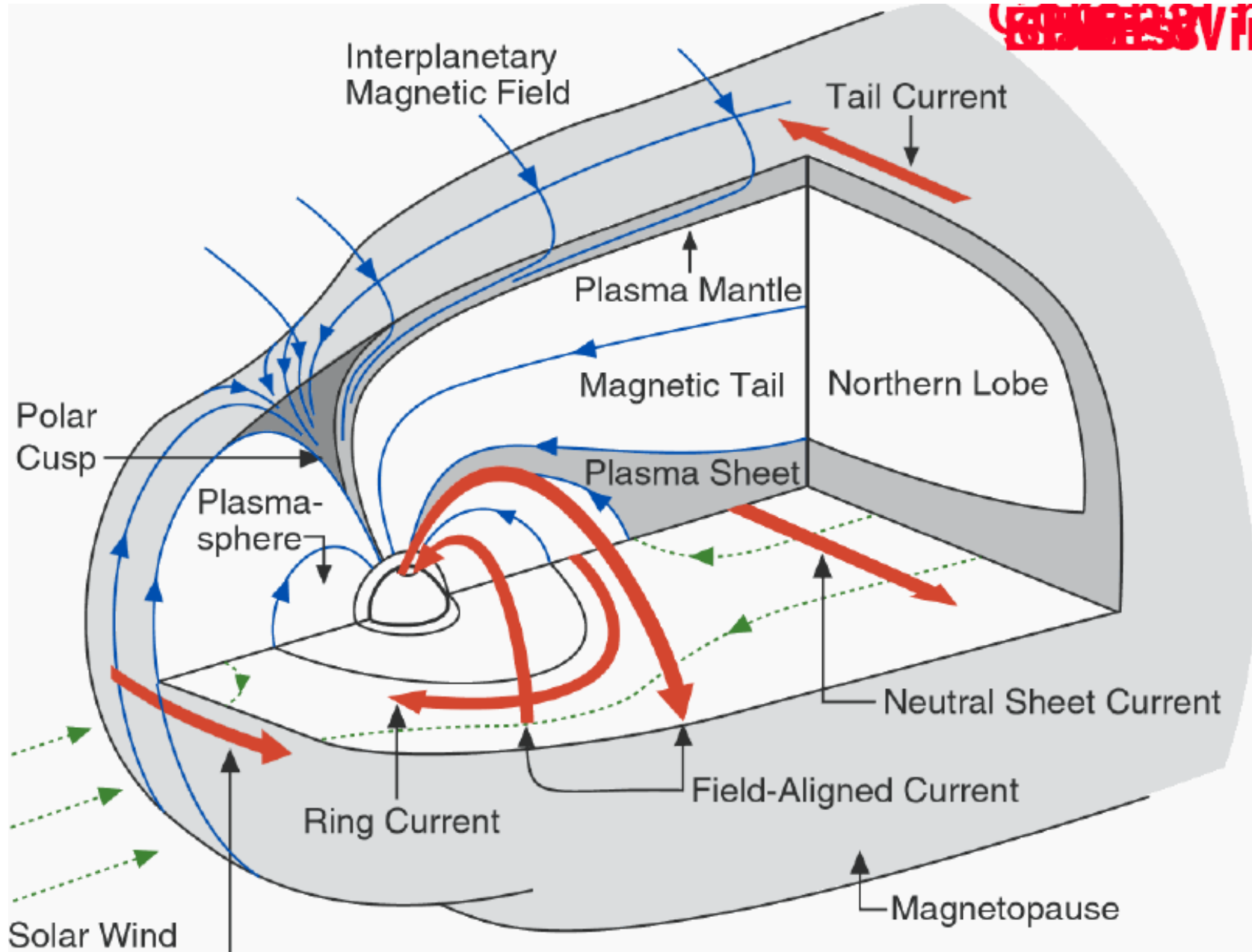

# Radiation belts and ring current

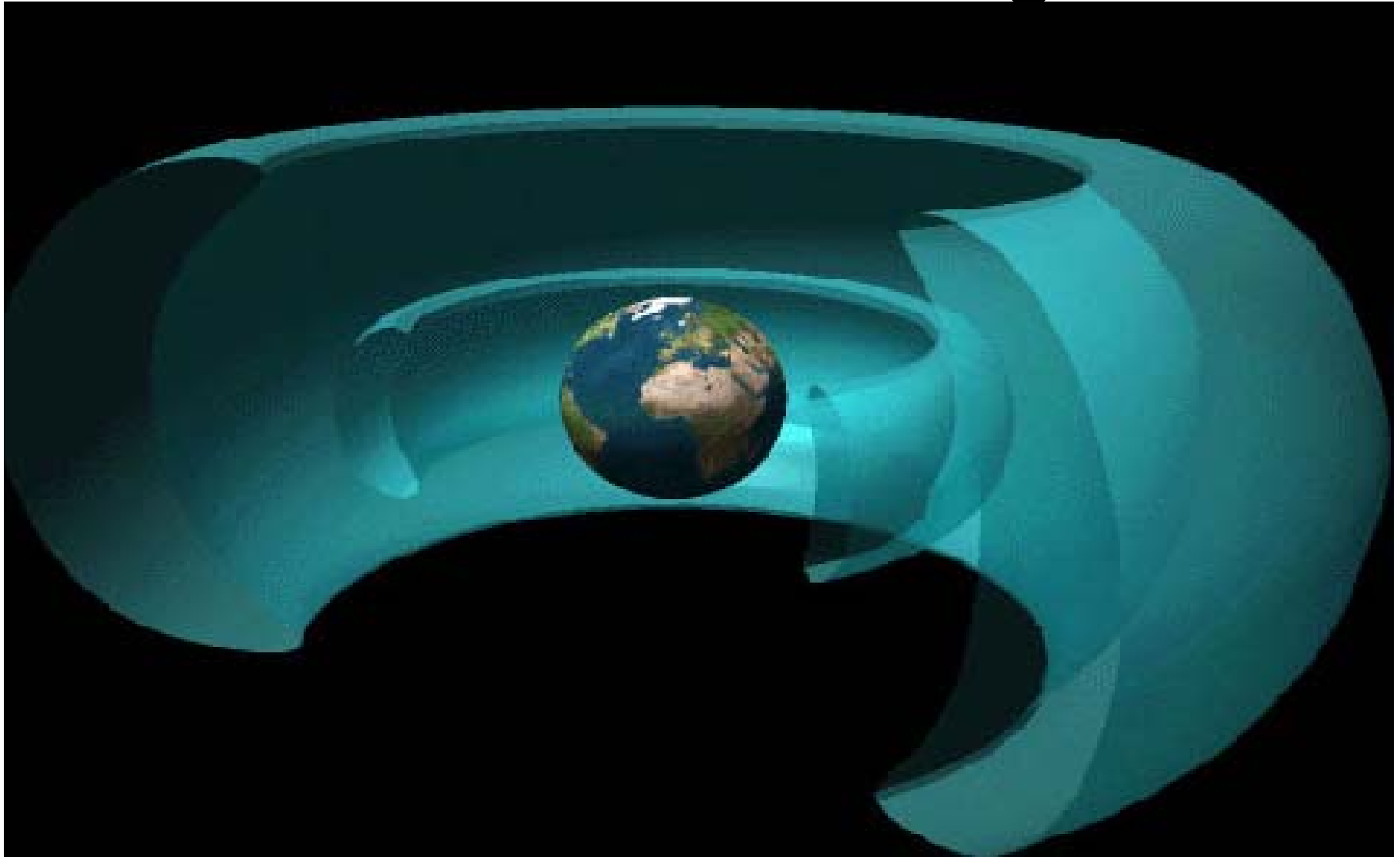

**Discovery: 1958 by Explorer/van Allen: trapped energetic (keV – MeV) electrons, accelerated in the magnetosphere.**

# Substorms

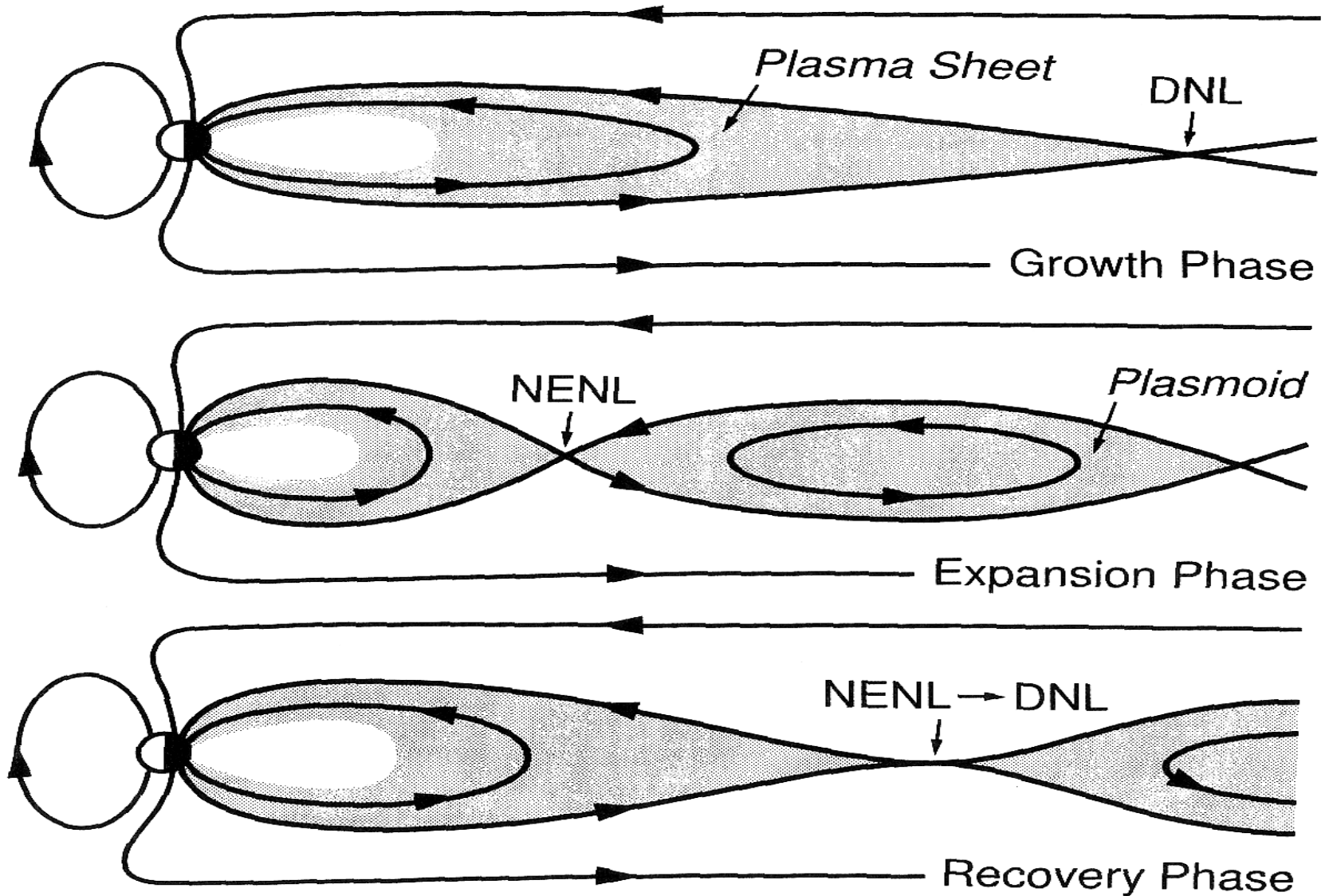

# The Substorm Current Wedge

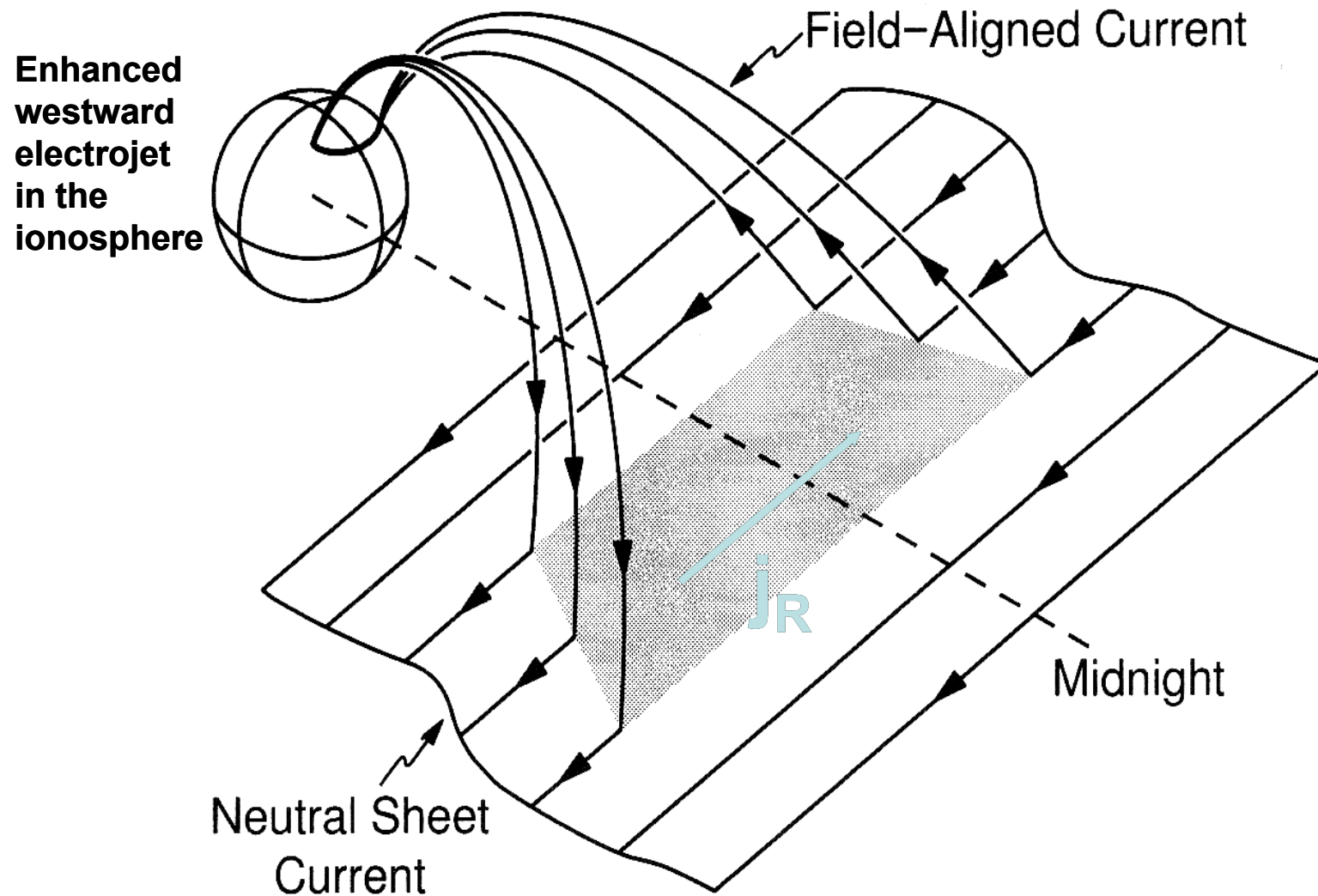

**Reference: R. L. McPherron, Magnetospheric substorms, Rev. Geophys. Space Phys., 1979.**

# Plasmasphere: Co-rotating plasma

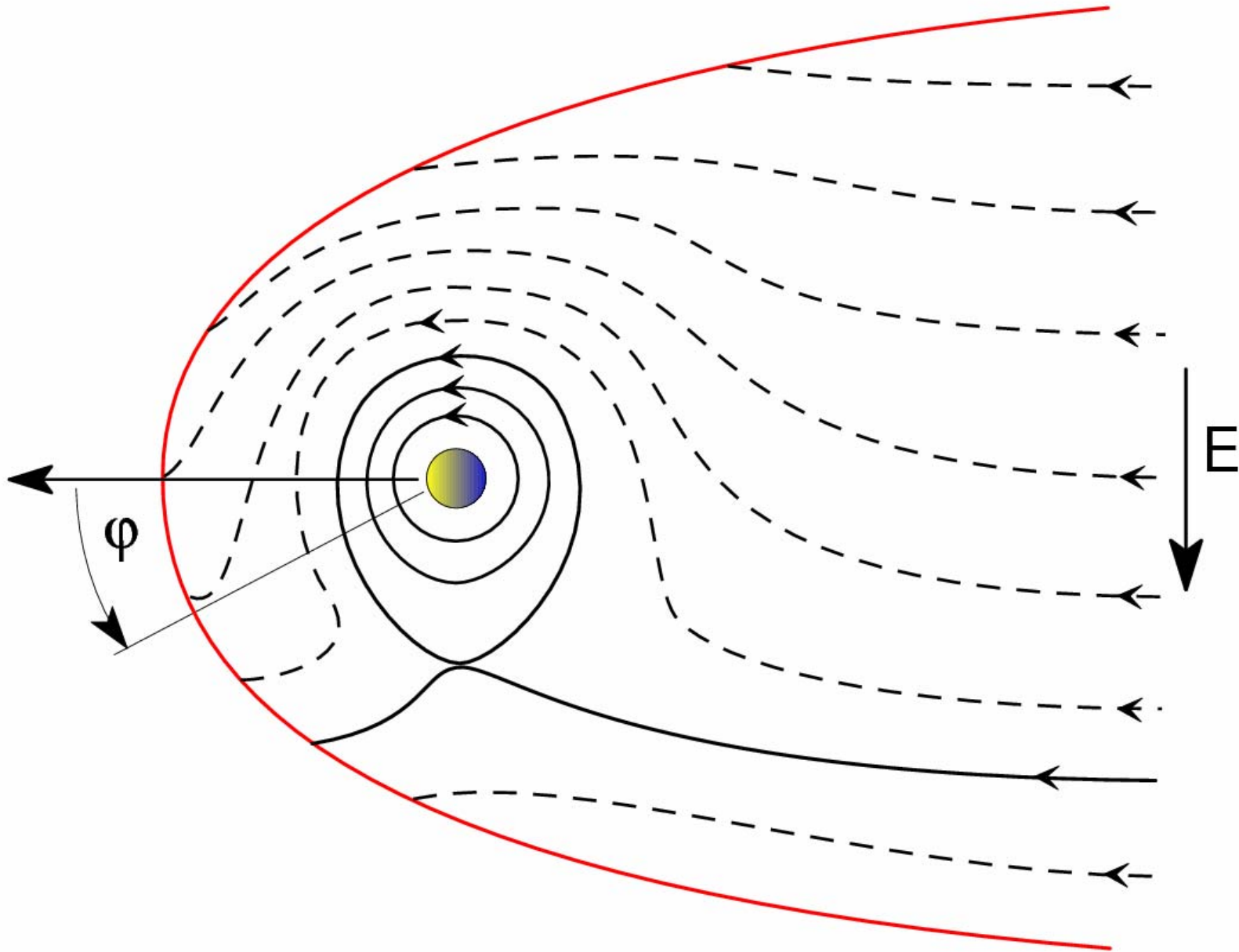

# The ionosphere

Neutral atmosphere stratified according to barometric law:

$$n_n(z) = n_0 \exp(-z/H)$$

$$H = k_B T_n / m_n g$$

= scale height

$g$  is the gravitational acceleration at  $z = 0$

$n_0$  is the plasma or the neutral density at  $z = 0$

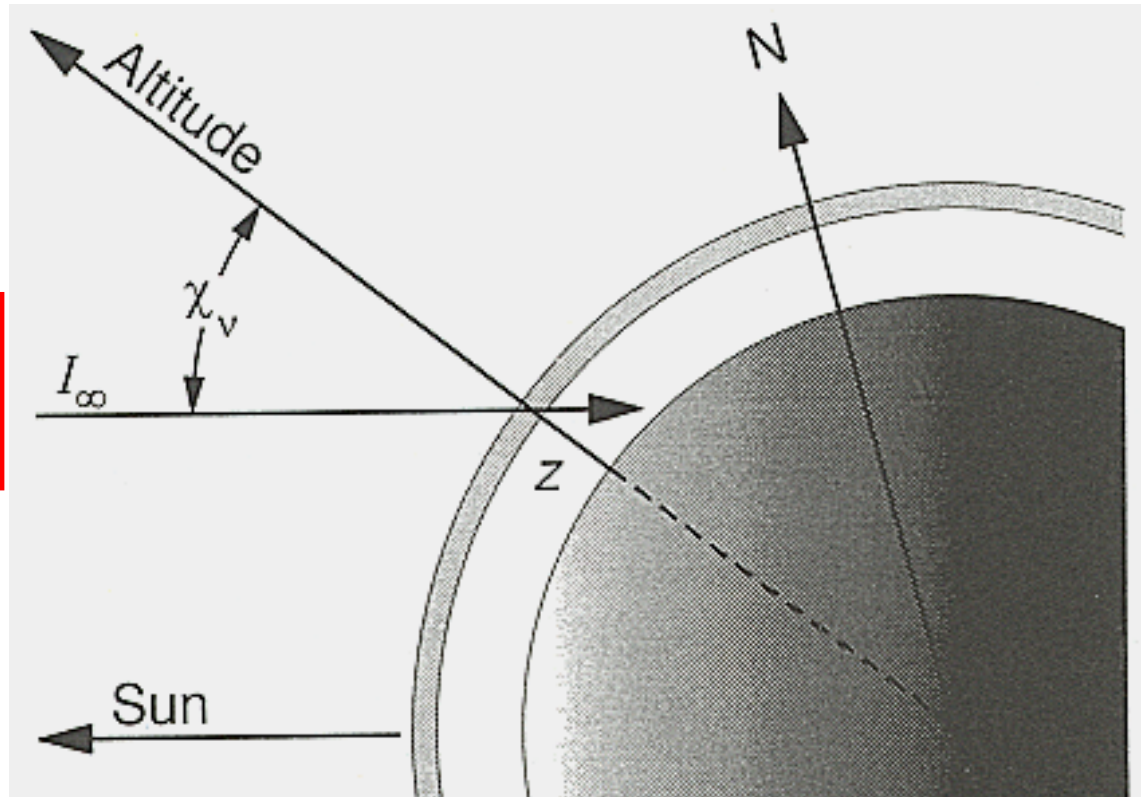

Solar ultraviolet radiation impinges at an angle  $\chi_v$ , the radiation is then absorbed in the upper atmosphere where it creates ionization (also through electron precipitation).

$I_\infty$  is the flux on top of the layer.

# Diminuation of the solar UV radiation

**Radiation transfer -> the solar radiation is diminished with altitude along the ray path in the atmosphere:**

$$dI = \sigma_{\nu} n_n \frac{dz}{\cos \chi_{\nu}} I$$

**$\sigma_{\nu}$  is the radiation absorption-cross.section for a photon of frequency  $\nu$ . Solving for the intensity ->**

$$I(z) = I_{\infty} \exp \left[ -\frac{\sigma_{\nu} n_0 H}{\cos \chi_{\nu}} \exp(-z/H) \right]$$

**This reveals an exponential decrease of the intensity of the solar ultraviolet radiation with height, the dashed line in the next figure.**



# Formation of the Chapman layer

$q_\nu(z)$ : electron-ion pairs produced by UV ionization  
proportional to the ionization efficiency,  $\kappa_\nu$  and absorbed  
radiation:  $q_\nu(z) = \kappa_\nu \sigma_\nu n_n I(z) \rightarrow$  Chapman layer:

$$q_\nu(z) = \kappa_\nu \sigma_\nu n_0 I_\infty \exp \left[ -\frac{z}{H} - \frac{\sigma_\nu n_0 H}{\cos \chi_\nu} \exp(-z/H) \right]$$

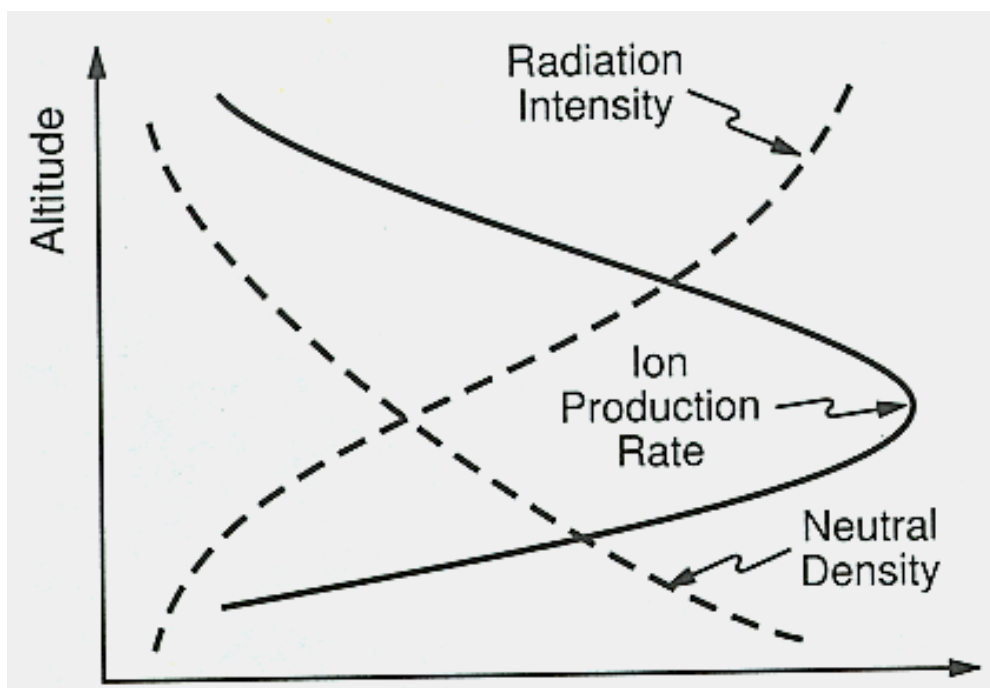

The location of the ionization maximum varies with time, season etc. Due to its importance for radio propagation it was called the F-layer, later D and E layers were discovered

# Local information: fleet of spacecraft

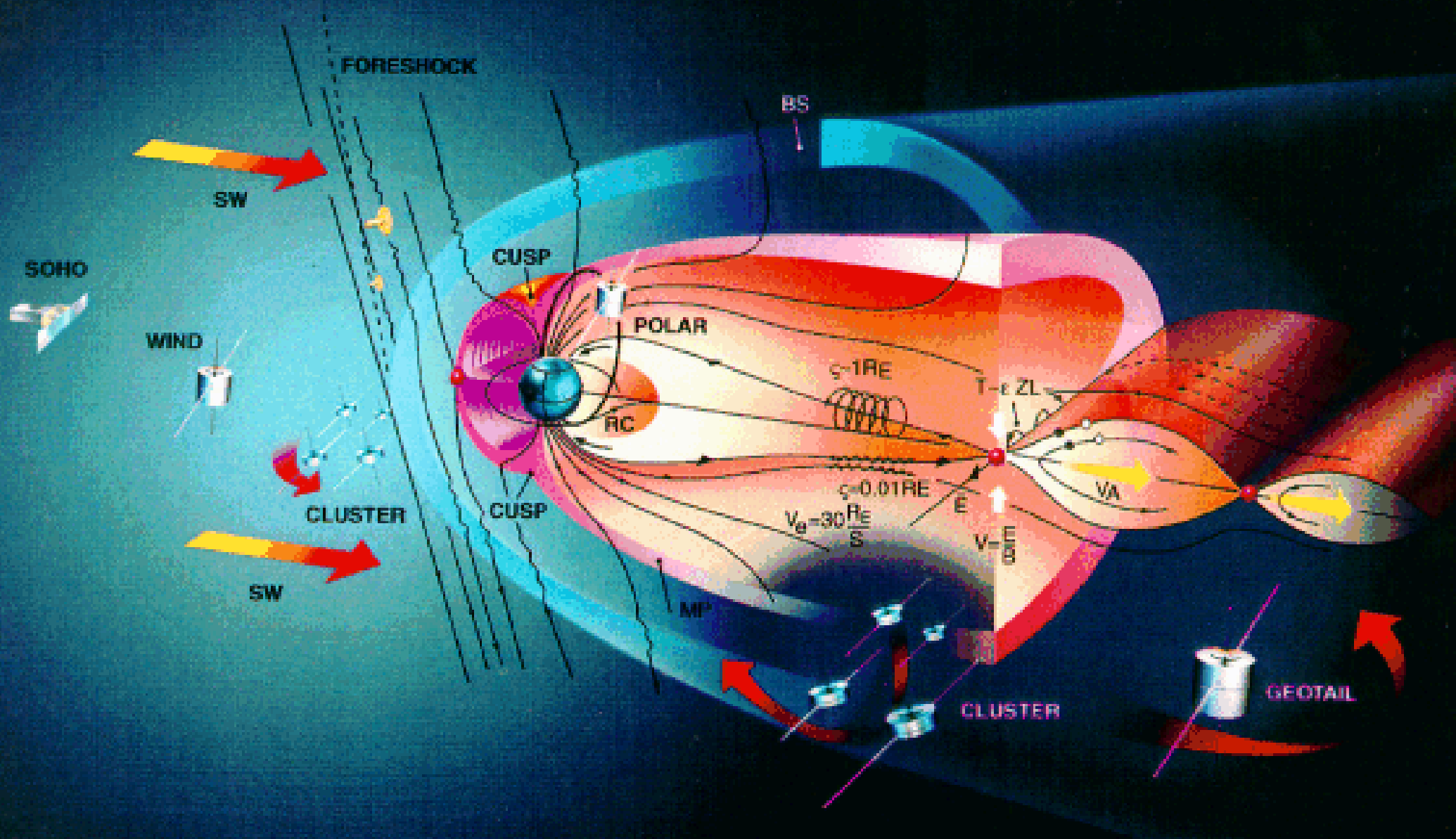

# Global dynamics: Numerical models

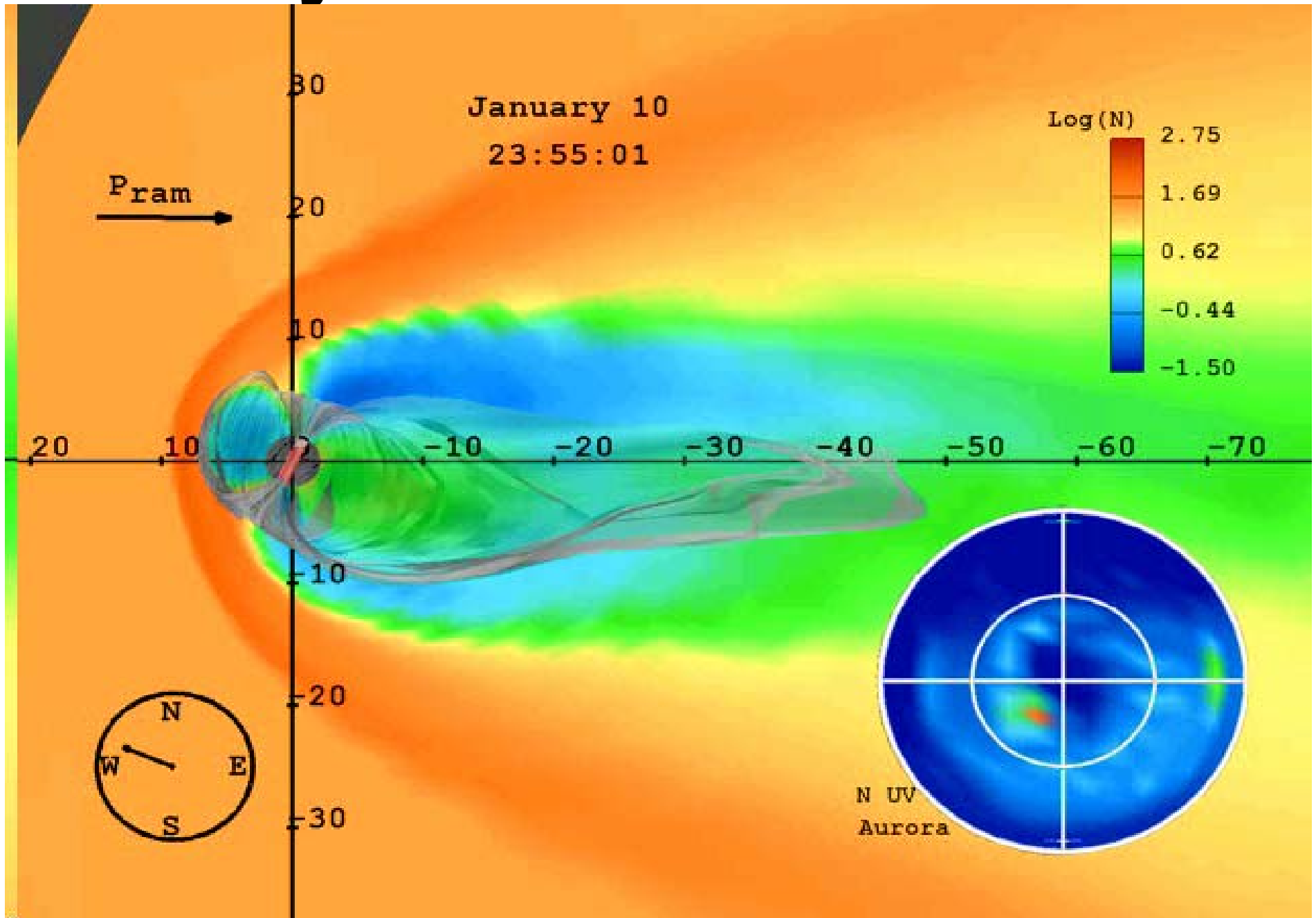

# Consequences: 1. Men in Space

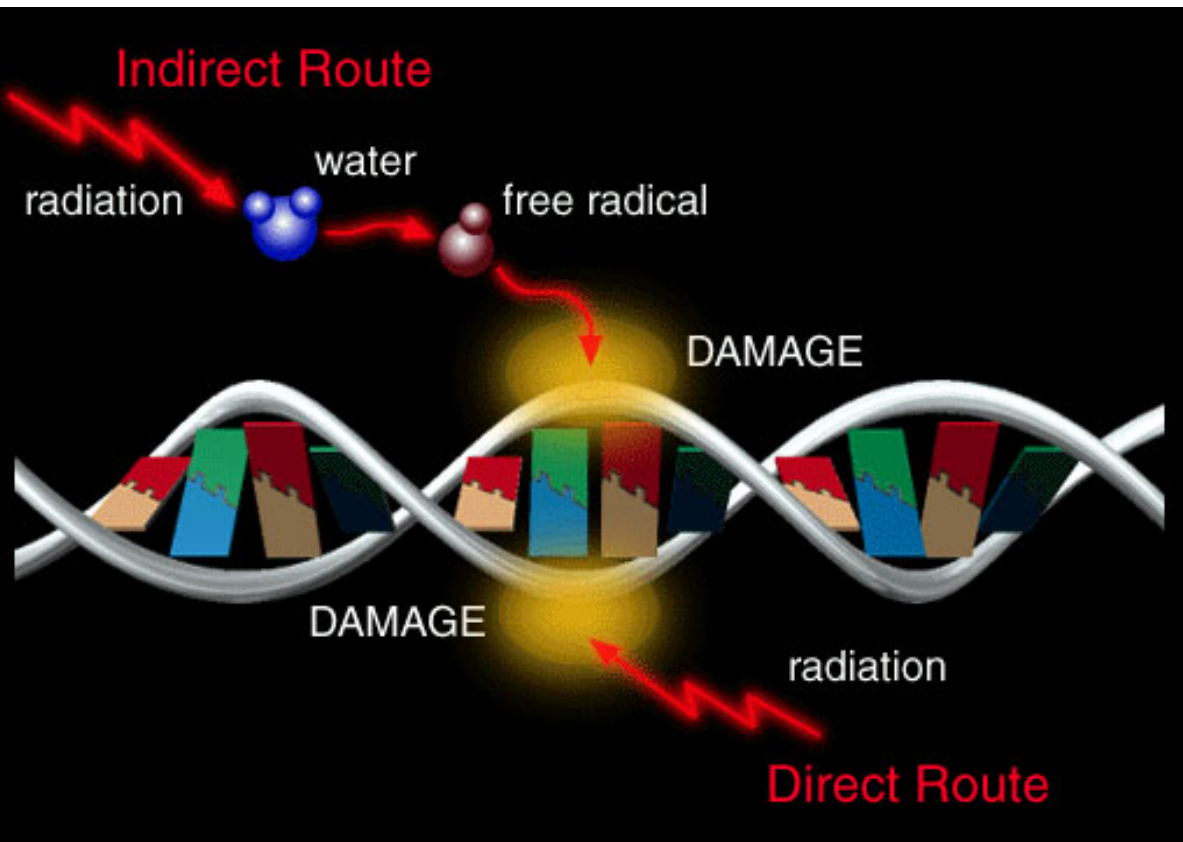
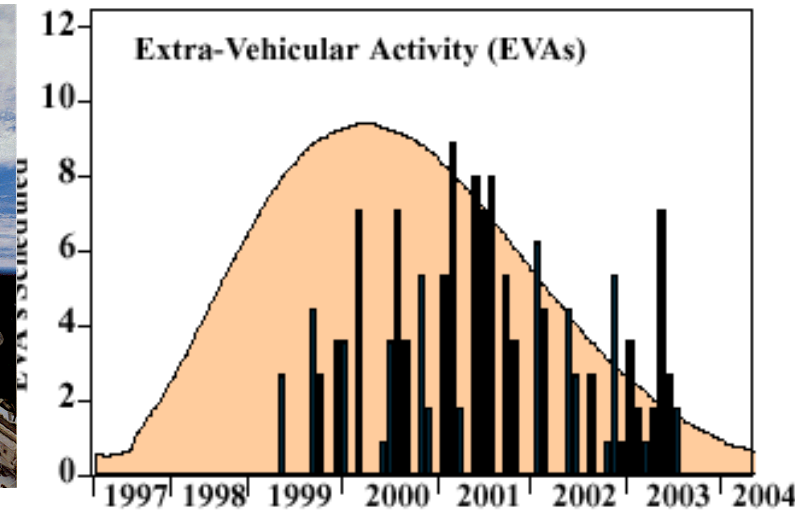

# 2. Danger for satellites

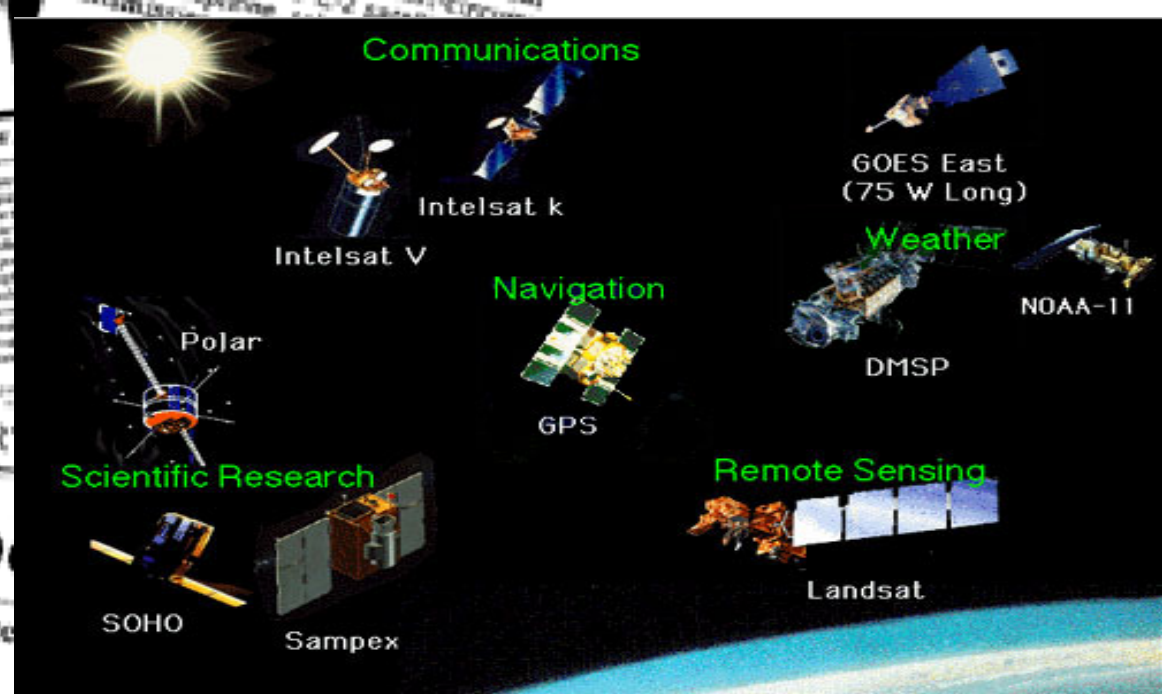
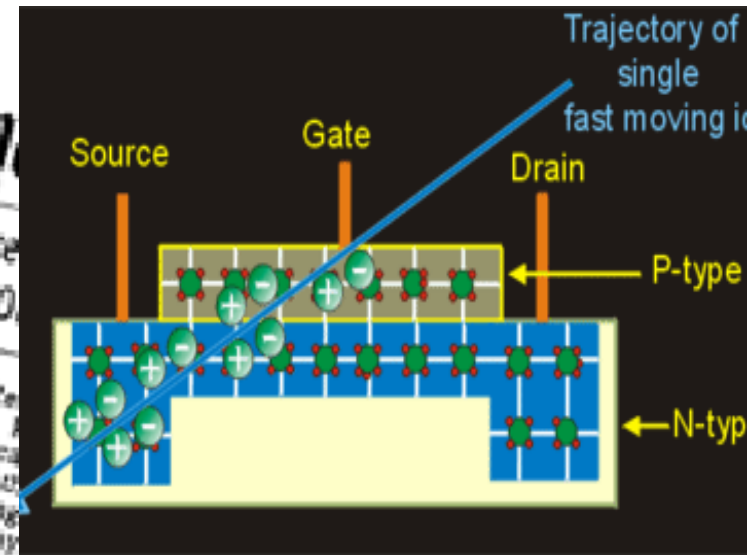

# Damage / loss of satellites

- Damaged microschemes (Anik 1)
- Disorientation of satellites
- contact lost (ESR-1, PRARE, Equator-S)
- Anomalous charges (Electrons)  
(Marecs, ECS, Meteosat, TELE-2)
- Degradation of solar panels  
(Tempo, PanAm, ECS)
- Total losses of satellites by solar storms (Telestar 401, Galaxy IV )
- Last four years: 5 Billion EUR lost

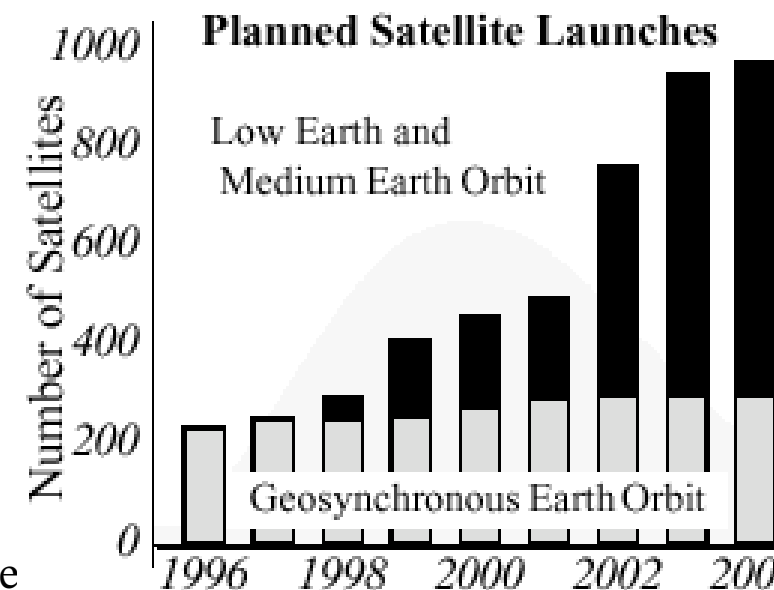
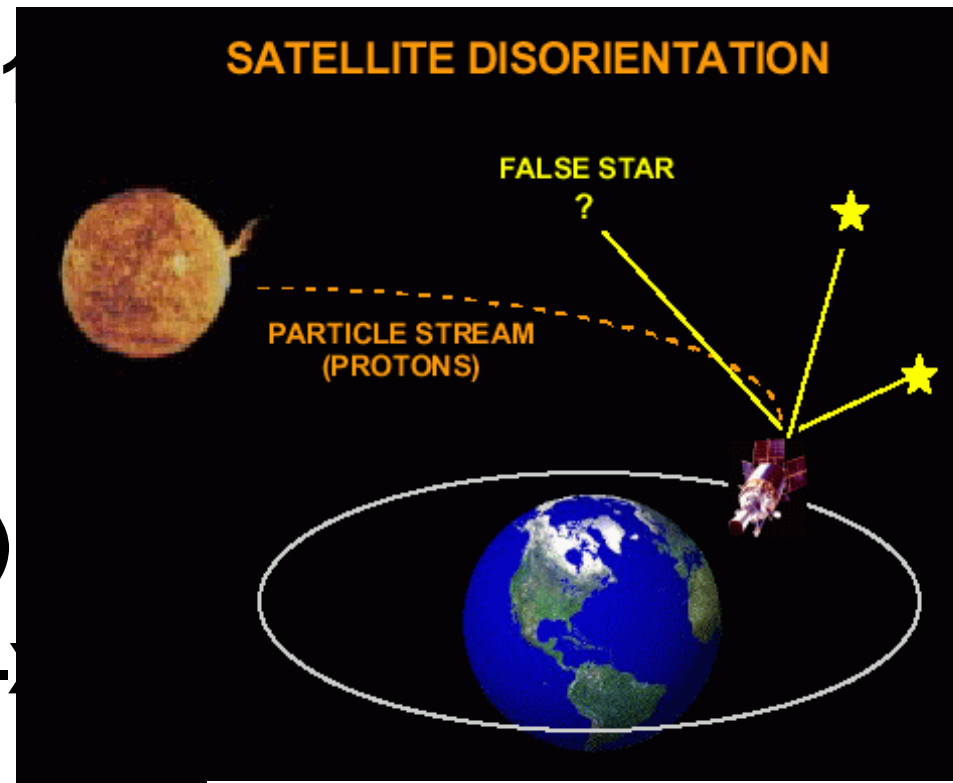

# Influence on navigation systems (GPS, GLONAS, GALILEO)

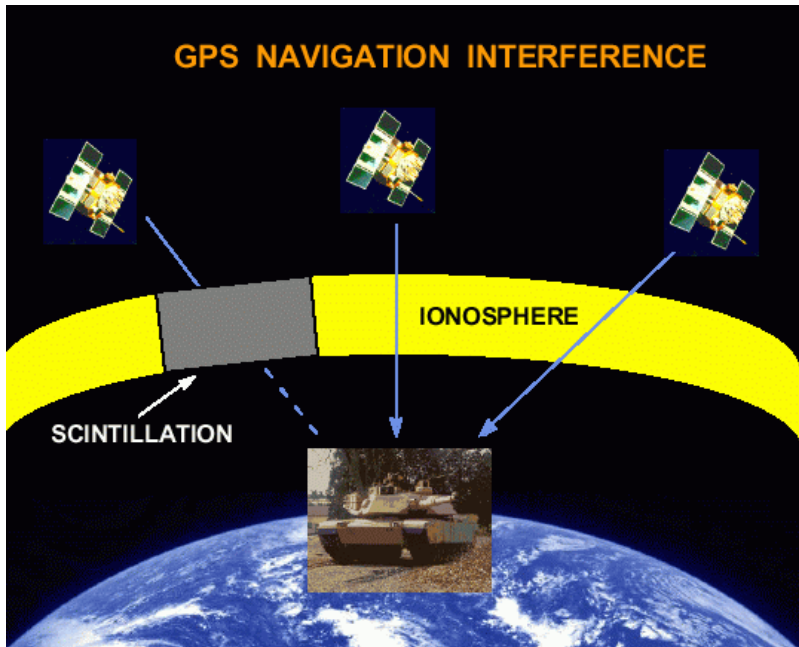

- Ionosphere between satellites and ground users becomes turbulent and irregular, Signals “scintillate” or are lost completely
- Changing total electron contents along the propagation path: errors in the GPS signal hundreds of meters
- Distortion of radio wave propagation (e.g. during Polar Cap Events PCE)

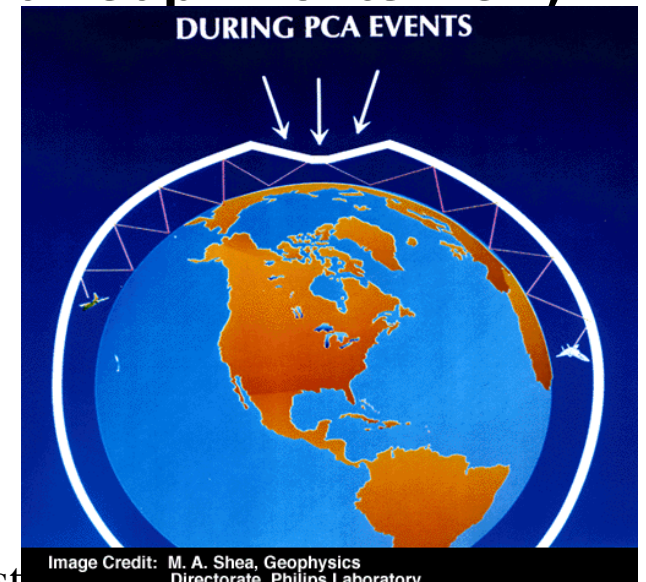
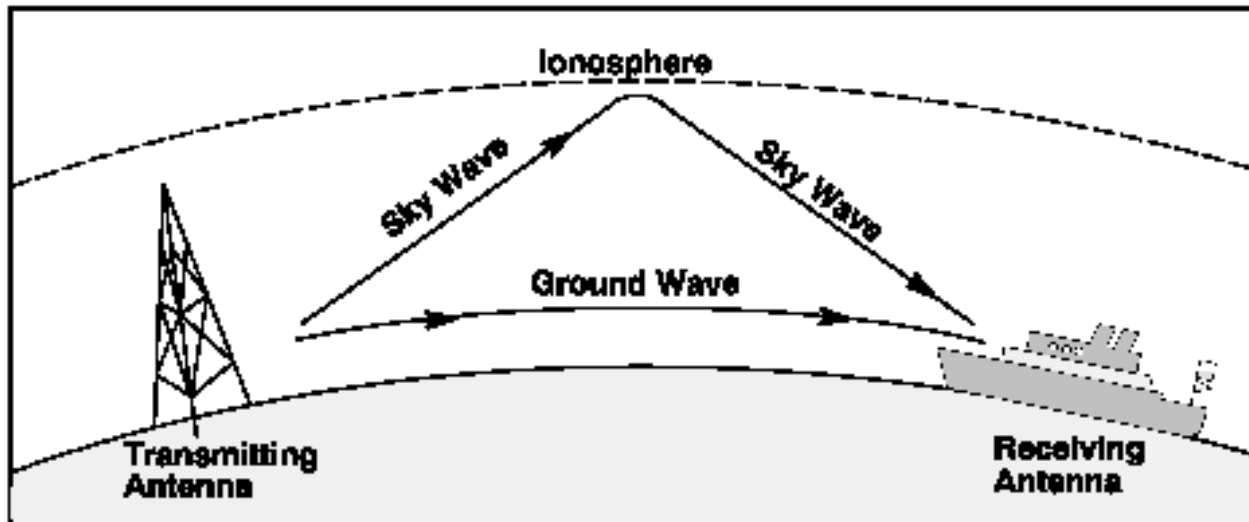
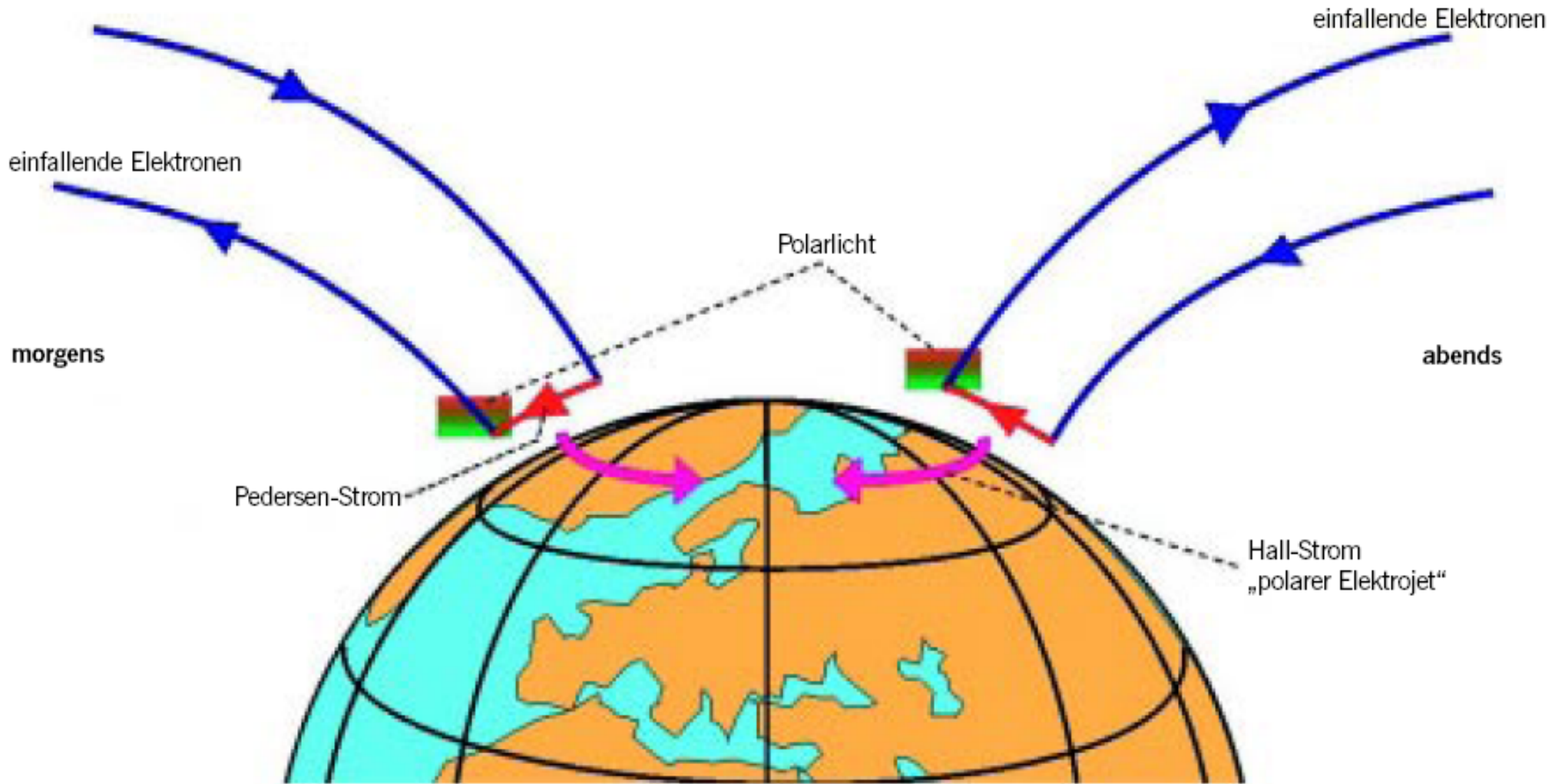

Image Credit: M. A. Shea, Geophysics Directorate, Philips Laboratory

# Consequences of currents



**Field aligned (Birkeland-) currents close via Pedersen currents, which produce Hall currents.**

**Electrons  $> 1$  keV cause aurora („polar lights“).**



# Aurorae



# Example: Bastille day 14.7.2000

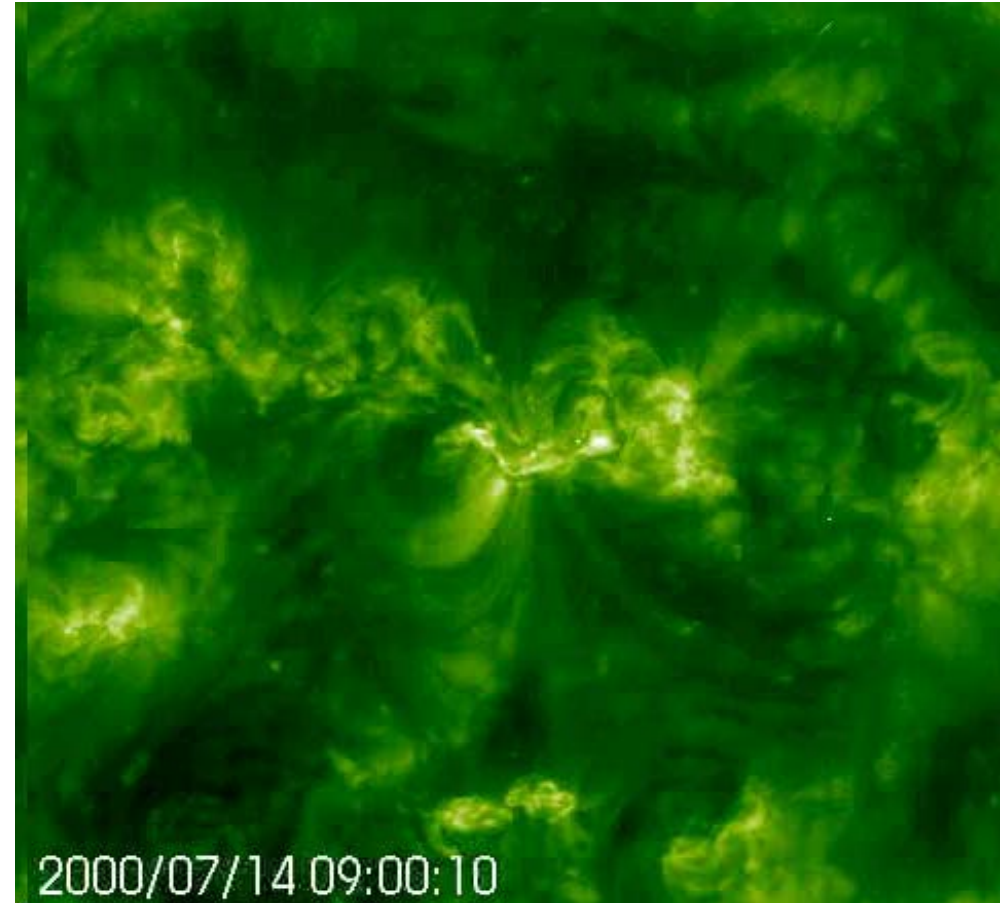
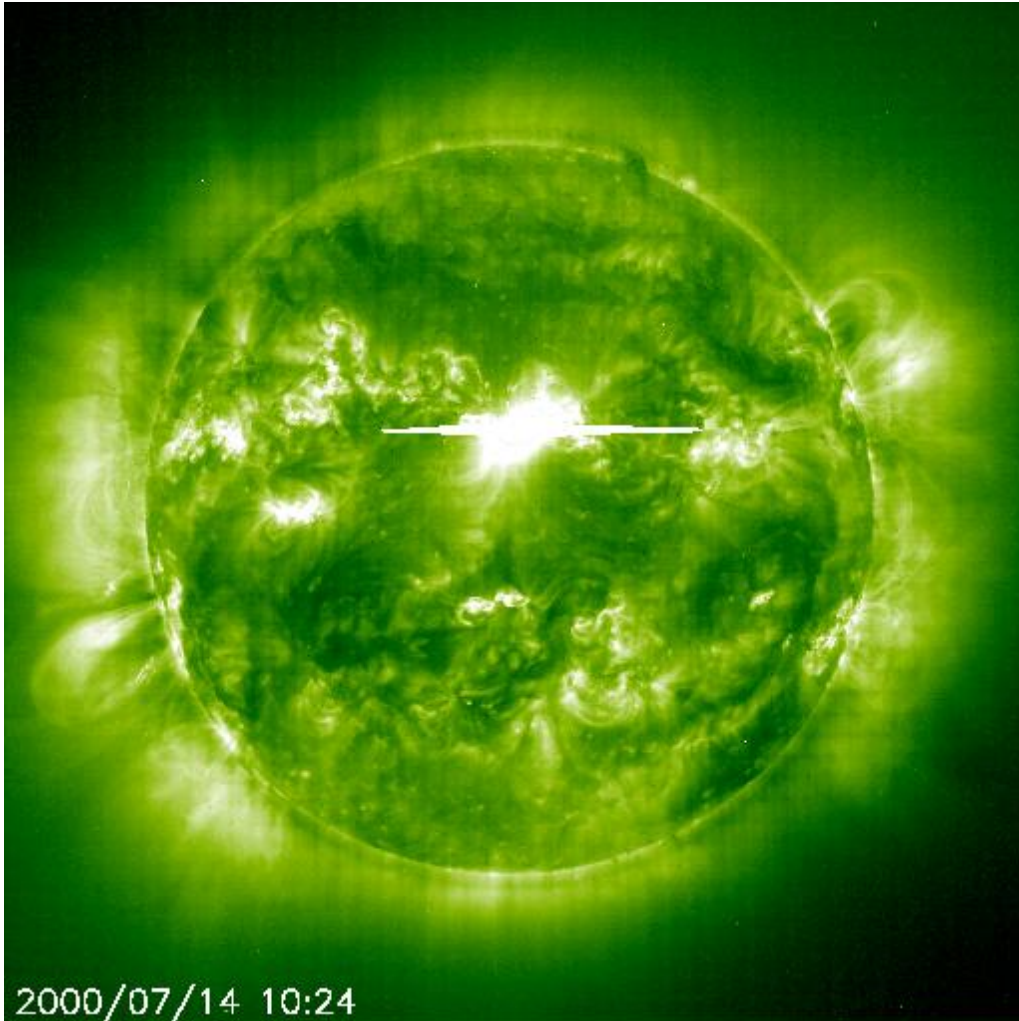

## Flare observation by SOHO EIT: movie

# Bastille day 14.7.00: LASCO

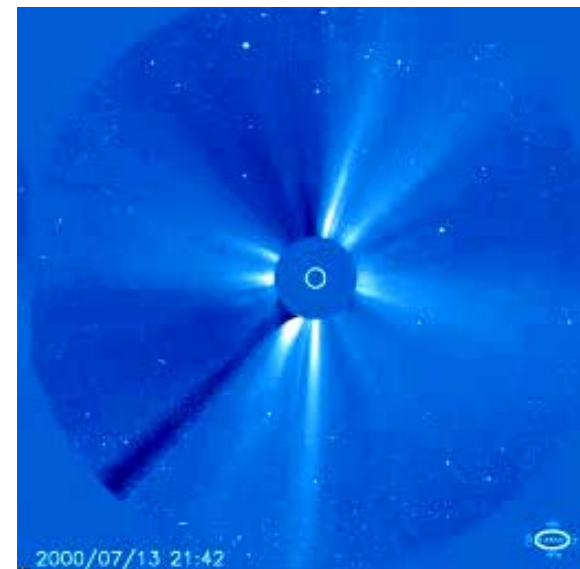
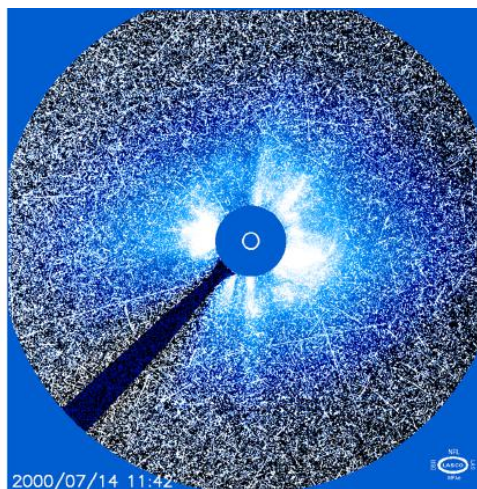
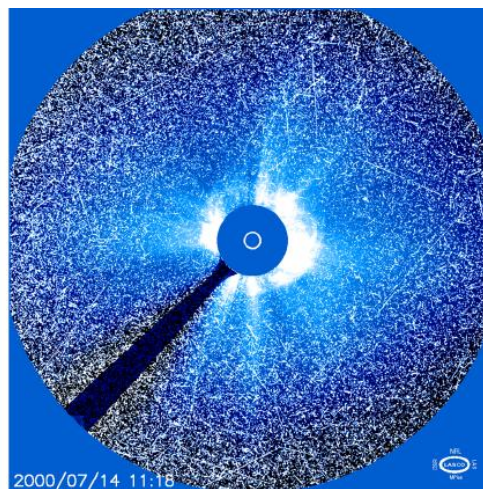
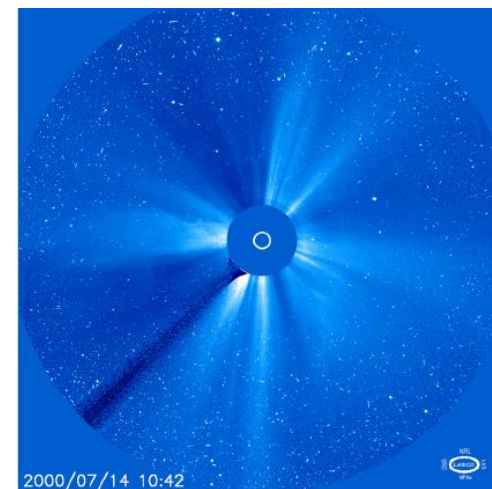
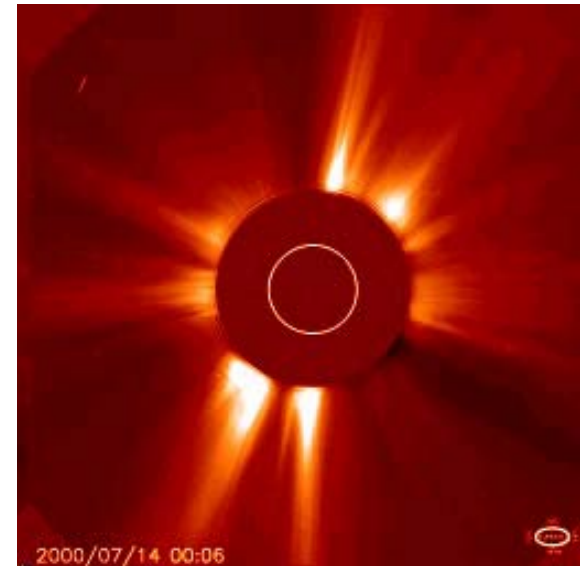
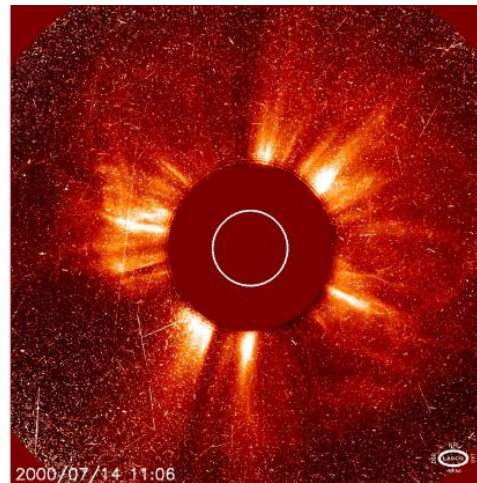
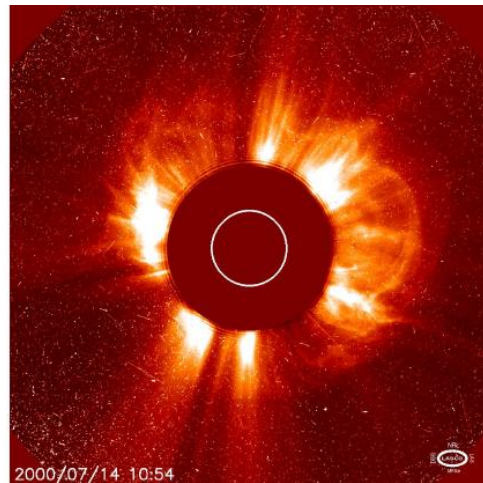
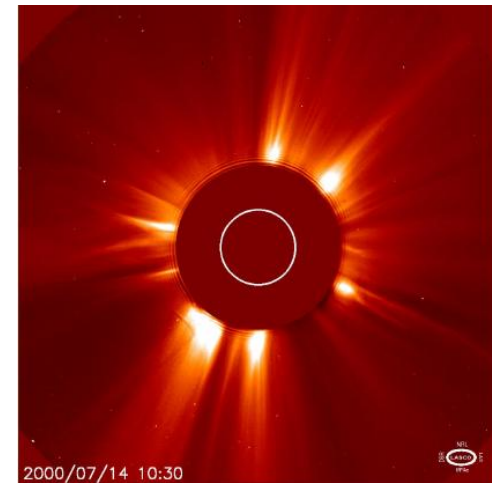

# Bastille day 14.7.00: particles

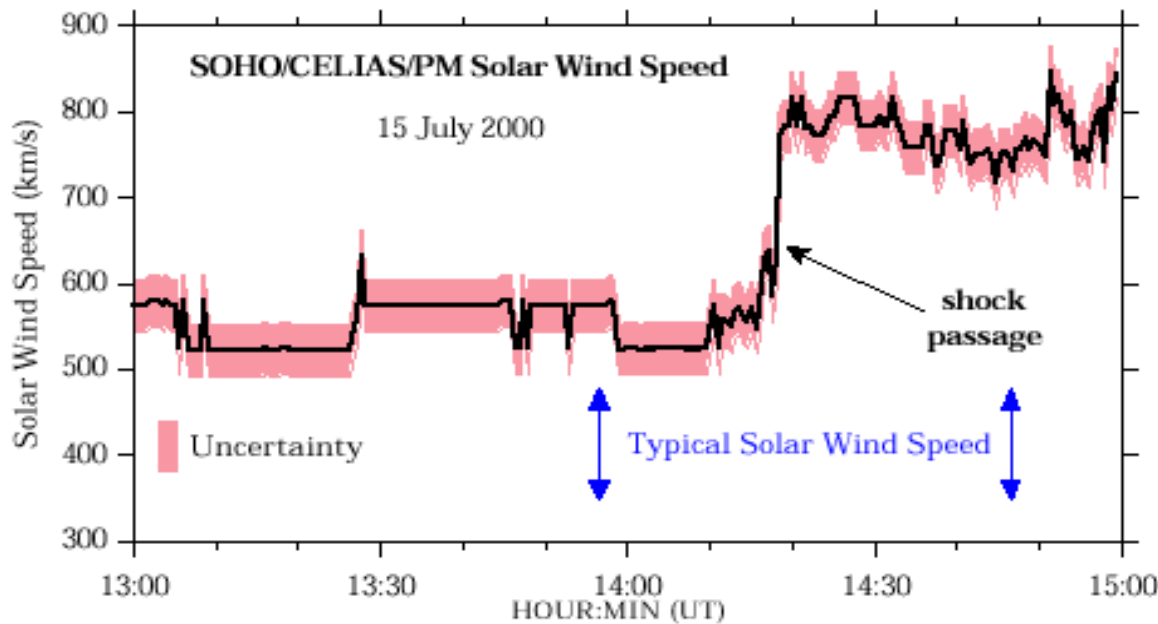
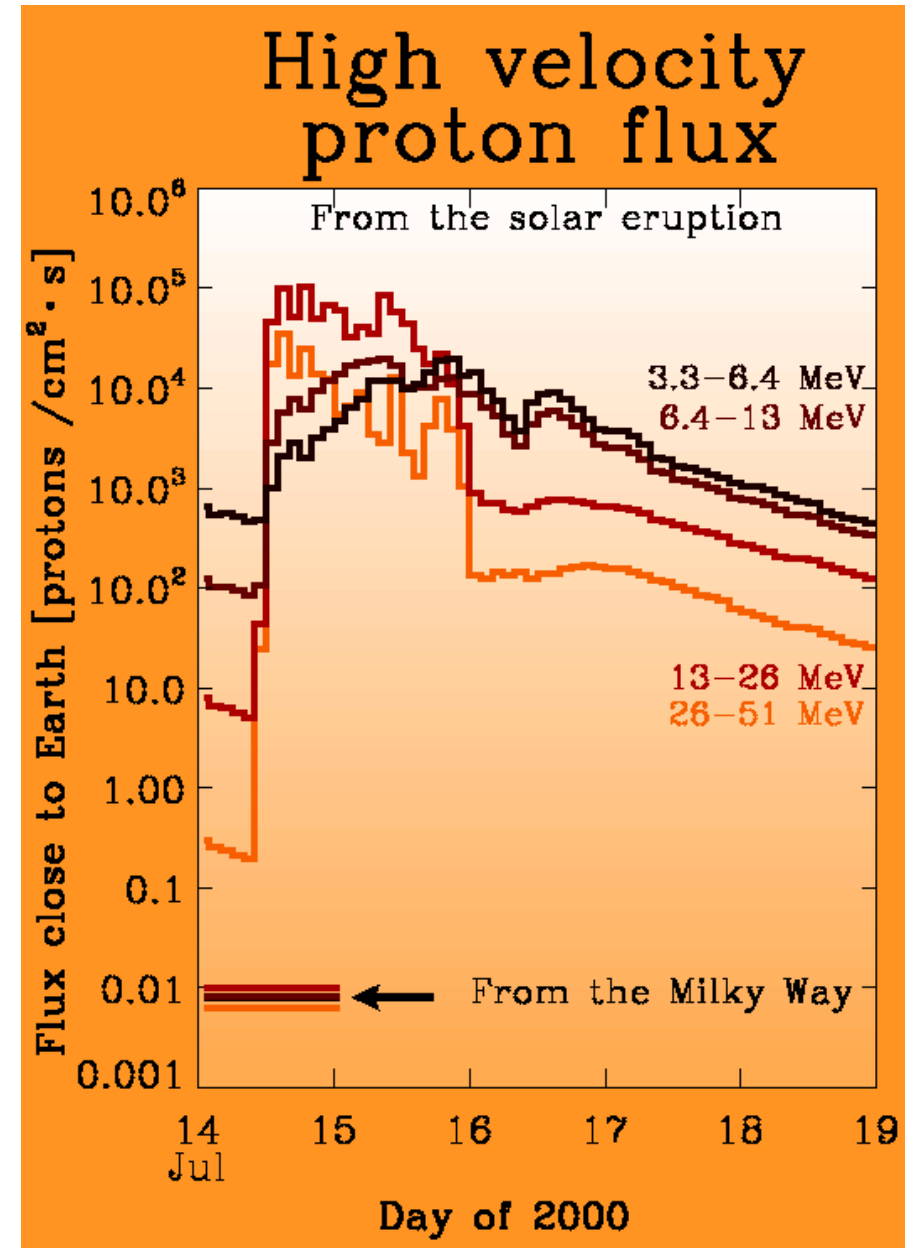
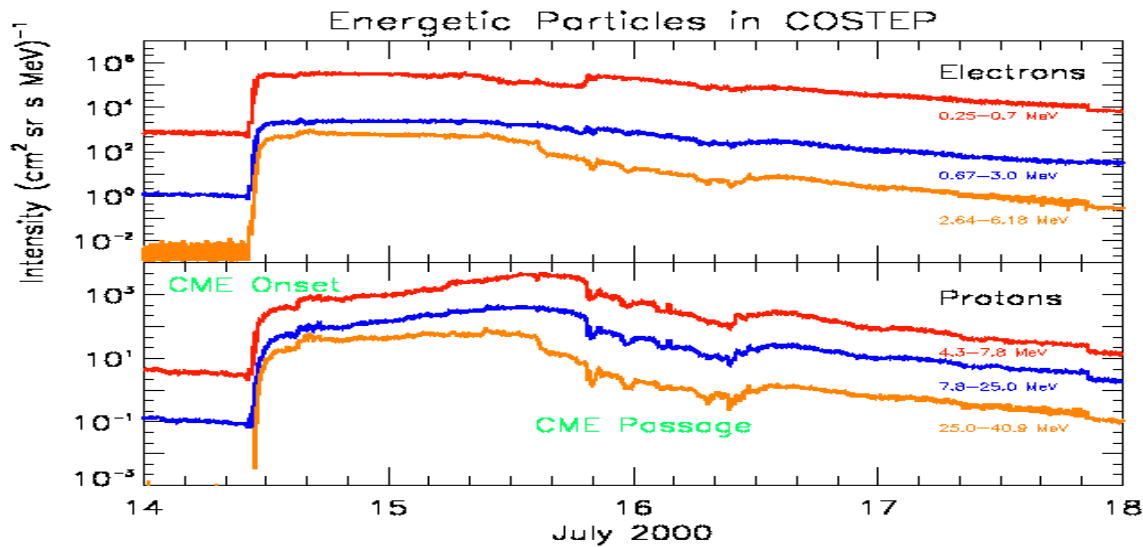

# Bastille day 14.7.00 aurorae

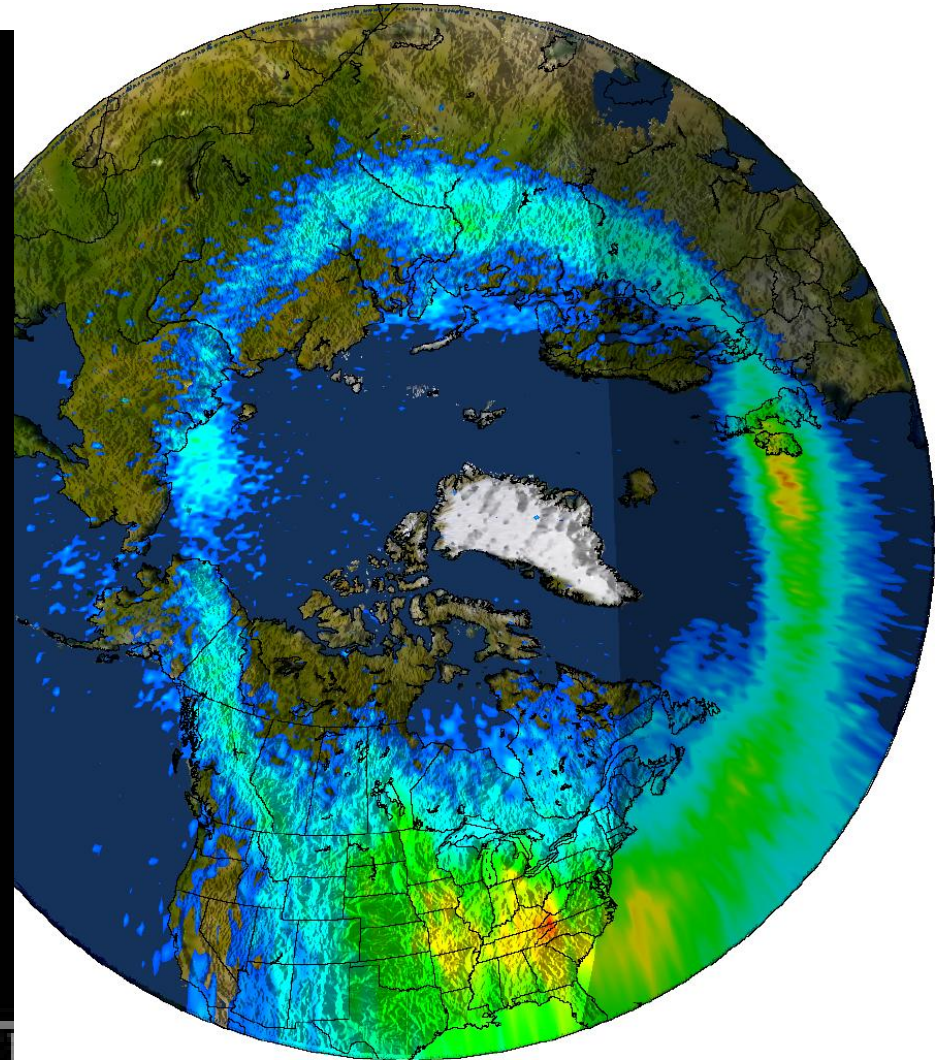

# Geomagnetic storms -> inductions

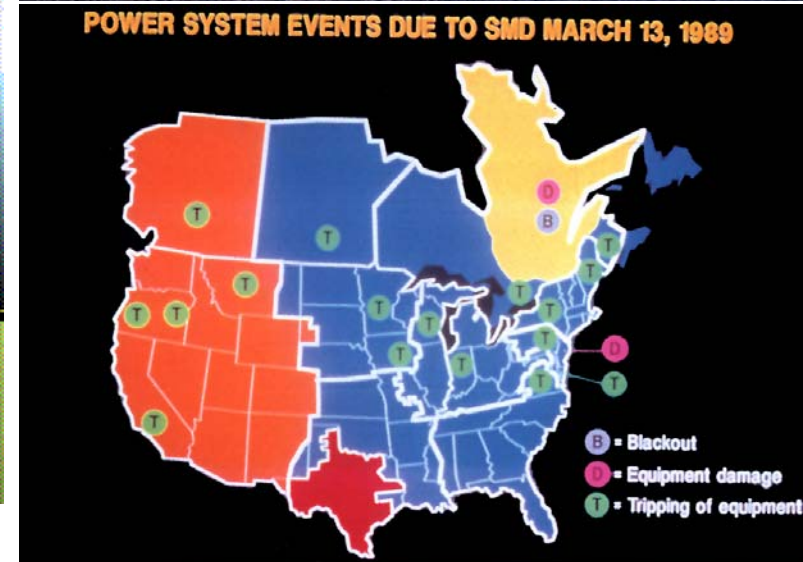
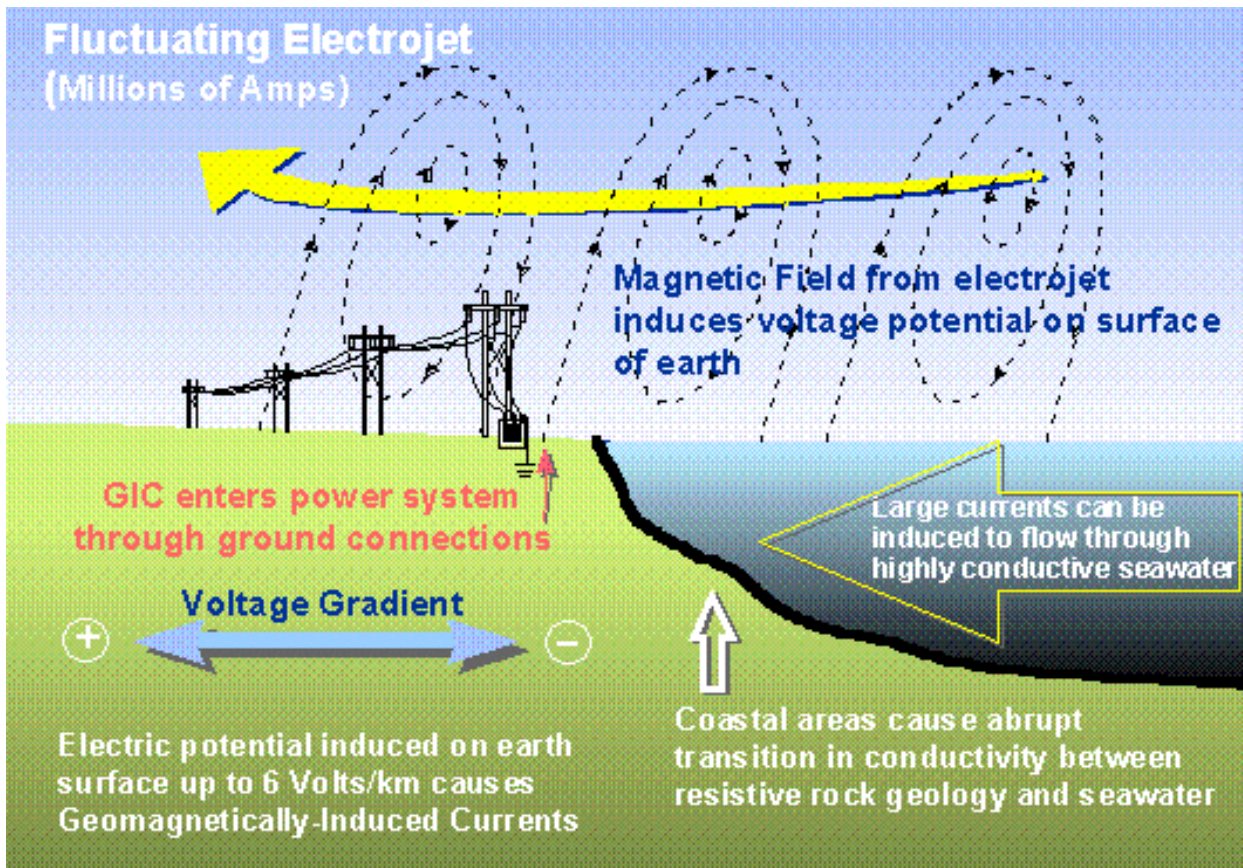

**Pipelines**

- **GICs = Geomagnetically Induced Currents**
- **Inductions into long pipelines**
- **Railway systems**
- **Communication lines**

# Burned Transformers



**March 1989: Delaware power station transformer damage**

**Sweden: Six 130 kV power lines disrupted**

**April 1994: Chicago station: Five Transformers lost**

# Summary: Solar influence

## Flares

**Electromagnetic radiation (X-rays, EUV, Radiobursts)**  
**Arrival: Immediate**  
**Duration: 1-2 hours**

## Consequences:

**Satellite communication disturbed,**  
**Radarinterferences**  
**Short waves fade away**

## CMEs und Flares

**Energetic protons**  
**Arrival: 15 minutes - hours**  
**Duration: days**

## Consequences:

**Disorientation of satellites, Sensor errors,**  
**Destruction of spacecraft**  
**Radiation danger for airplanes at heights**

## CMEs, coronal holes

**Plasma and particles**  
**Arrival: 2-4 days**  
**Duration: days**

## Consequences:

**Geomagnetic storms,**  
**Satellite charges,**  
**Navigation Errors**  
**Radar-interferences**  
**Wave propagation anomalies**  
**Power outages,**  
**Staining of pipelines**



# Summary: Space Weather

