

Space Instrumentation:

Measuring Magnetic Fields in Space

Dr. Ingo Richter

i.richter@tu-bs.de

Institute for Geophysics and extraterrestrial Physics

TU- Braunschweig

MPS Lindau 5.12.2006



... the next hour

- The Magnetic field
- Magnetometers:
 - Torsional Magnetometer
 - Fluxgate-Magnetometer
 - Searchcoil Magnetometer
- Magnetometer Calibration
- Magnetic Cleanliness

The Magnetic field

The Magnetic field Maxwell Equations

Name or Description	SI
Faraday's law	$\nabla \times \mathbf{E} = -\frac{\partial \mathbf{B}}{\partial t}$
Ampere's law	$\nabla \times \mathbf{H} = \frac{\partial \mathbf{D}}{\partial t} + \mathbf{J}$
Poisson equation [Absence of magnetic monopoles]	$\nabla \cdot \mathbf{D} = \rho$ $\nabla \cdot \mathbf{B} = 0$
Lorentz force on charge q	$q(\mathbf{E} + \mathbf{v} \times \mathbf{B})$
Constitutive relations	$\mathbf{D} = \epsilon \mathbf{E}$ $\mathbf{B} = \mu \mathbf{H}$

The Magnetic field

The pure Earth

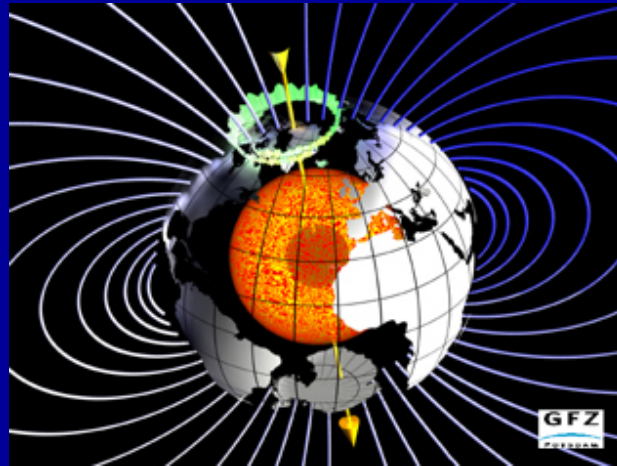

The Magnetic field

Horizontal and Vertical components



Declination



Inclination

The Magnetic field Ground Observations- I

... a calm day

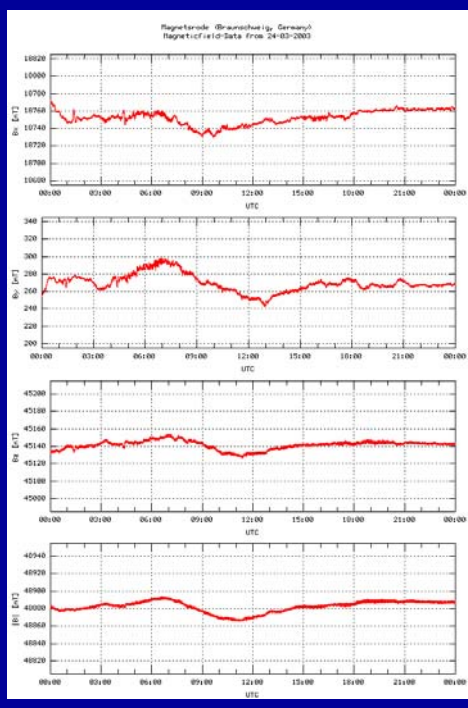

The Magnetic field Ground Observations- II

... a disturbed day

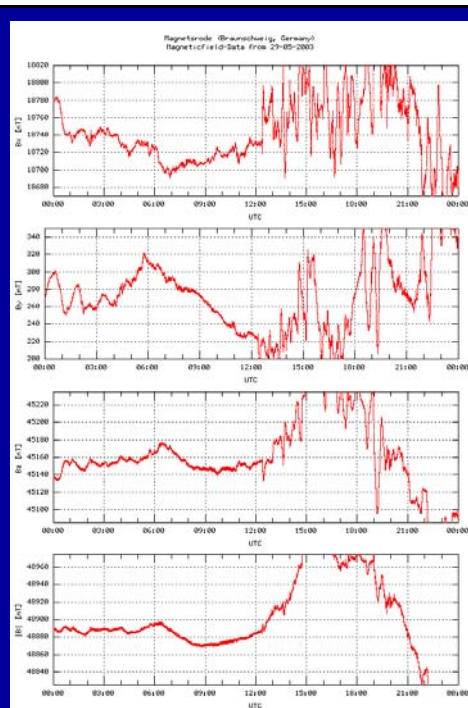

The Magnetic field The real Earth

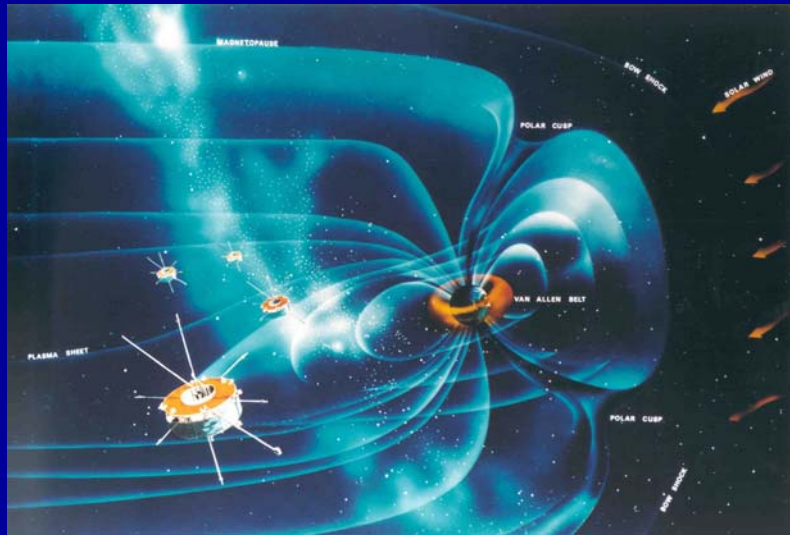

The Magnetic field The Sun

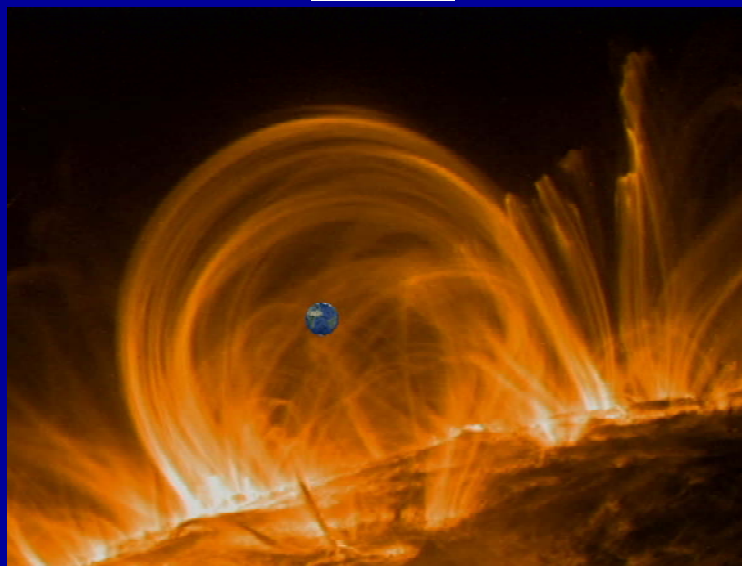

The Magnetic field Comets

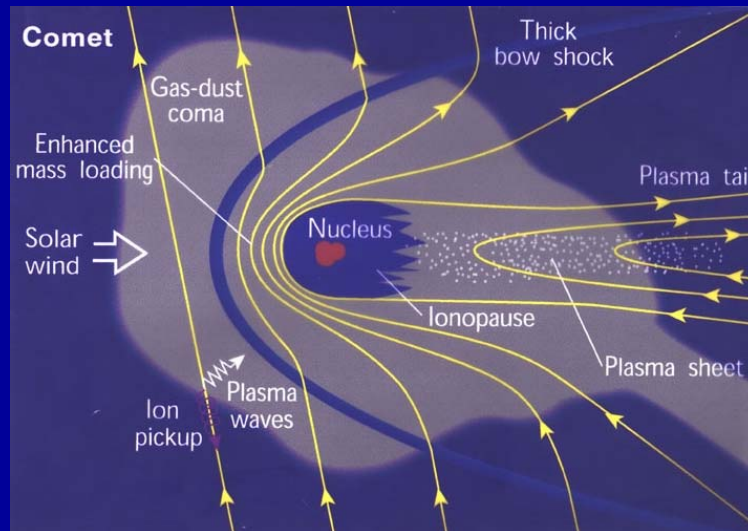

The Magnetic field Cometary Structures

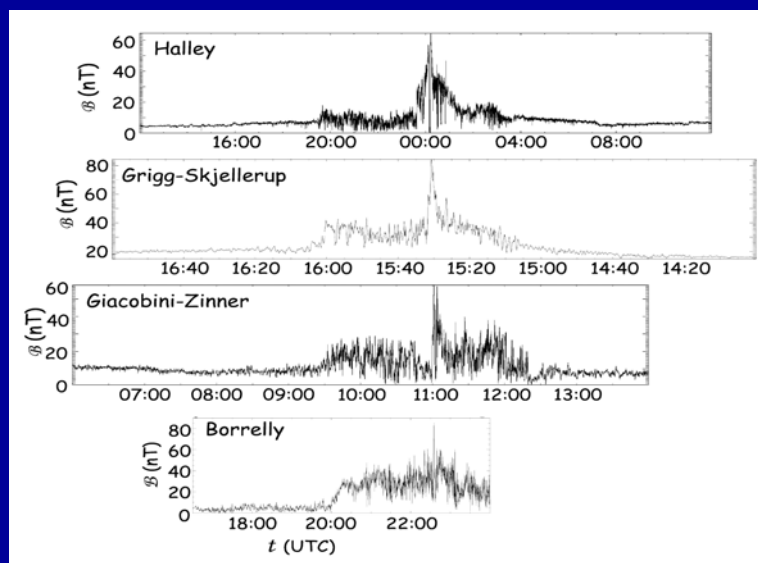

Magnetometers

Magnetometers

Design Criteria for s/c Magnetometers

- Long term Stability
- Range (SW, Planetary fields)
- Resolution (ADC)
- Vector Rate, TM-Budget
- Filters (Aliasing, Order, Cut off)
- Commanding
- Power & Mass (Size)
- Position

Magnetometers

Overview

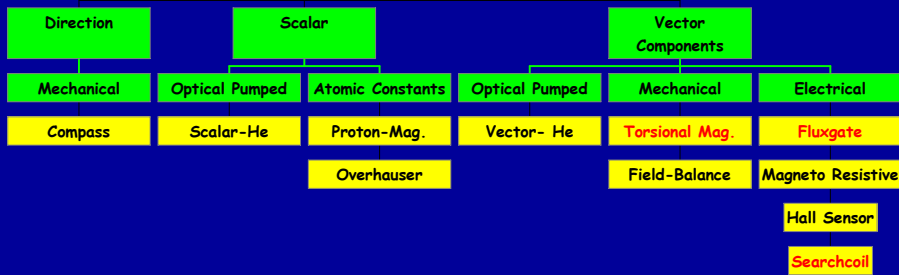

Torsional Magnetometer

A Classical Instrument

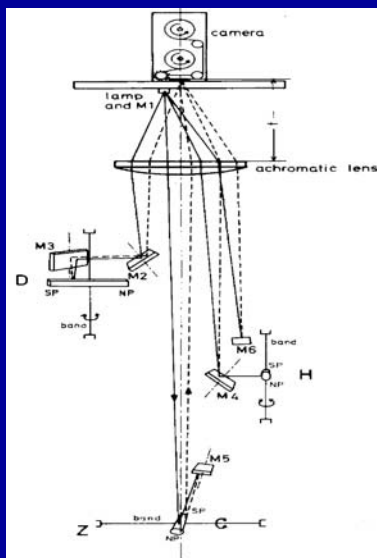

The idea:
 A magnet, suspended by a torsional wire, is rotating under the action of the Earth magnetic field. The rotational position of the magnet is determined by a light pointer and recorded on a normal film

Torsional Magnetometer

The z-Component of the Gough-Reitzel Magnetometer

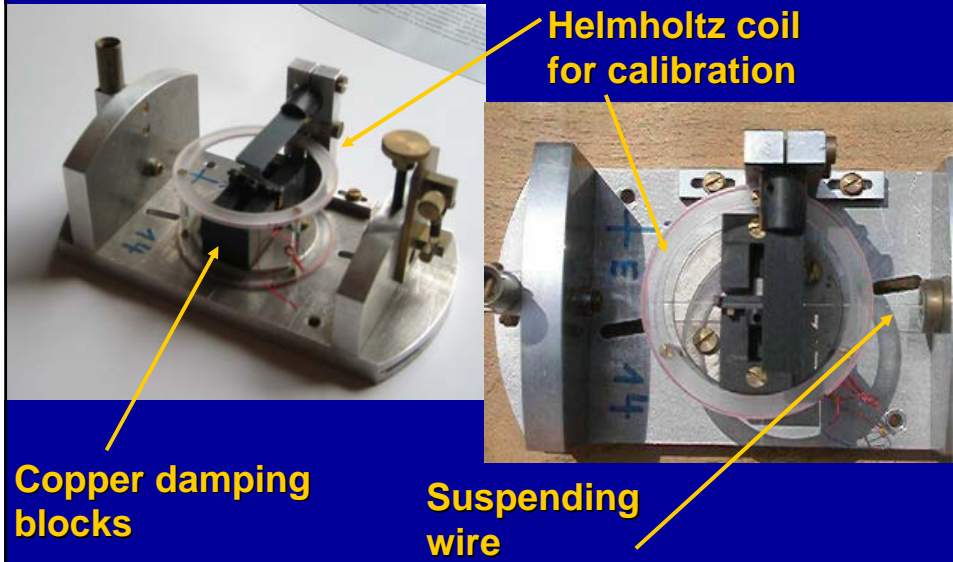

Torsional Magnetometer

Magnet and Suspending Wire

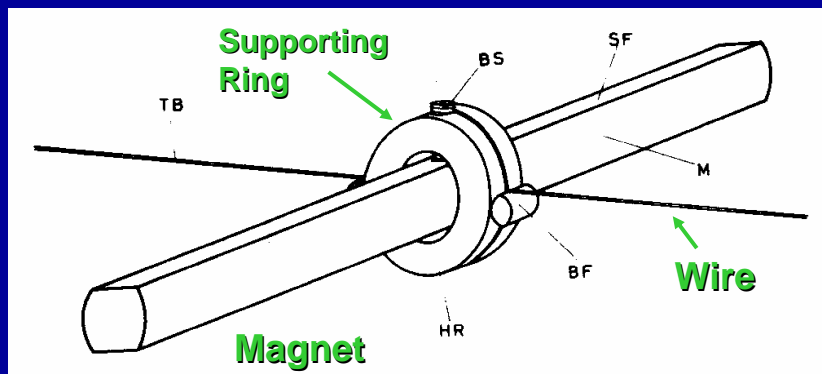

Torsional Magnetometer

Angular Momentum Balance for the z-component

The x-axis is aligned with the wire, the z-axis is vertical, and Y completes the system. Thus the angular momentum balance equation reads:

$$M \cdot H_z - D \cdot \alpha = 0$$

where M is the magnetic moment, H_z the vertical component of the field, D the torsional module, and α the torsional angle. It follows

$$H_z = \frac{D}{M} \alpha$$

Calibration determines D/M . Similar equations for H_x and H_y .

Torsional Magnetometer

A Sample Record

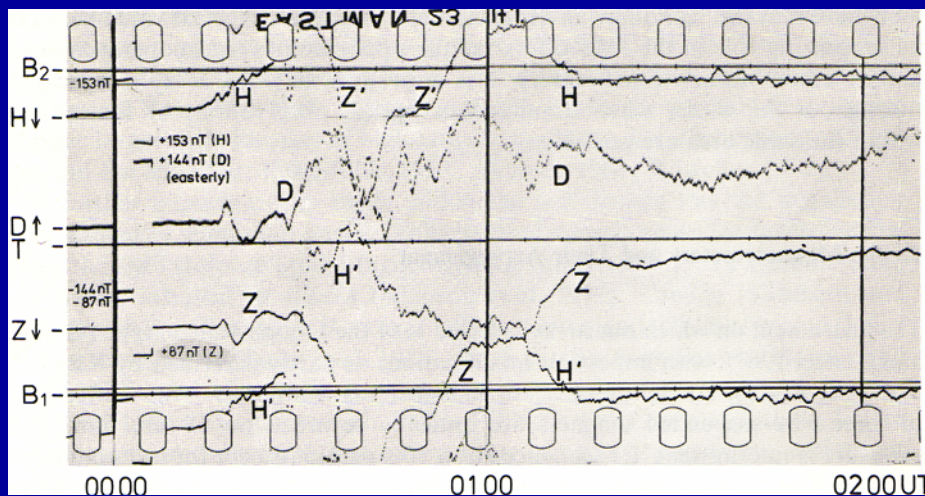

Torsional Magnetometer Characteristics

Weight:	10 kg
Power:	40 mW
Operating period:	70 days
Sampling:	0.2 vectors/s
Resolution:	1 nT
Dynamics range:	1500 nT

Fluxgate - Magnetometer (FGM) Examples GIOTTO FGM System

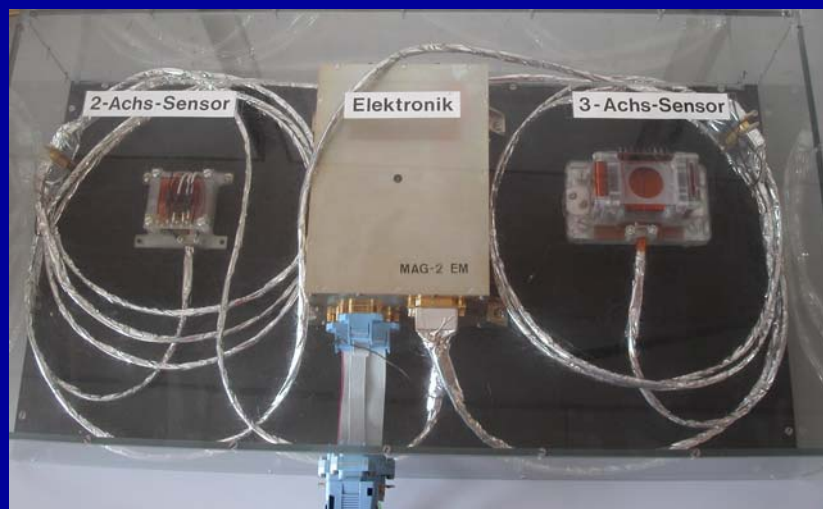

Fluxgate - Magnetometer (FGM) Classification

- Saturated-Core-Magnetometer
- Vector measurements possible
- No absolute measurements
- Lightweight, compact construction
- Low power consumption
- Qualified for space applications

Fluxgate - Magnetometer (FGM) Characteristic Curve, Excitation and Output Voltage

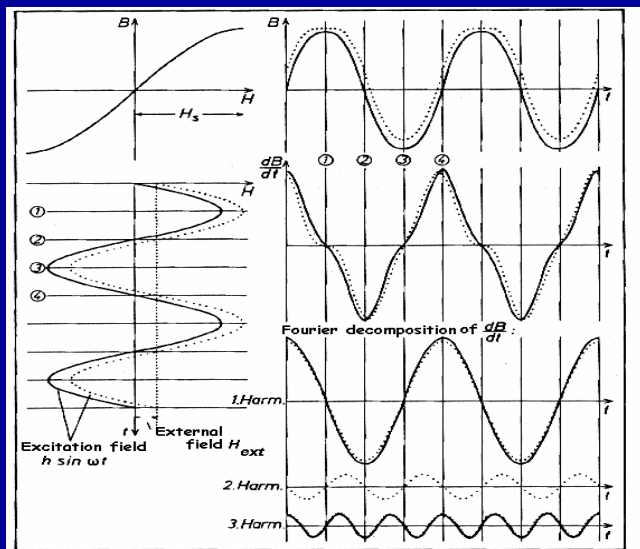

Fluxgate - Magnetometer (FGM)

Characteristic Curve, Excitation and Output Voltage

- **Characteristic curve:**

$$B(H(t)) = 3 H(t) - H(t)^3$$
- **Excitation:**

$$H(t) = H_{\text{ext}} + h \sin(\omega t)$$
- **Induced voltage at the secondary coil:**

$$U_i \sim dB/dt = 3 h (1 - H_{\text{ext}}^2 - 1/4 h^2) \omega \cos(\omega t) - 3 H_{\text{ext}} h^2 \omega \sin(2 \omega t) + 3/4 h^3 \omega \cos(3 \omega t)$$

Fluxgate - Magnetometer (FGM)

Schematic Construction

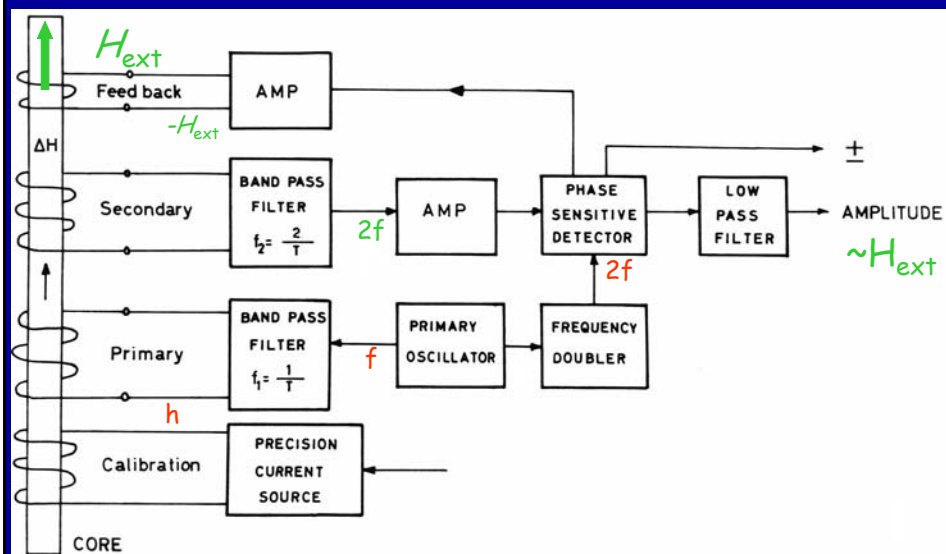

Fluxgate - Magnetometer (FGM)

Functional Principle: Summary

- Non-linear magnetization curve is driven into saturation by periodic excitation (f)
- External field $H_{ext} \Rightarrow (2f)$
- Lock-in ($2f$), PSD, Integration \rightarrow
 $\langle U_{2f} \rangle \sim B_{ext}$
- Feedback using $-\langle U_{2f} \rangle \Rightarrow$ Zero field and reduction of non-linearities
- Symmetric core excitation \Rightarrow DC-offset reduction
- Pulsed excitation \Rightarrow less power consumption

Fluxgate - Magnetometer (FGM)

Sensor Design

Problem:

Decoupling of small 2nd harmonic from the excitation signal

Solution:

Suitable sensor geometry for suppression of odd harmonics

Fluxgate - Magnetometer (FGM)

Sensor Design:

Rod Core

Simple excitation coil, simple secondary coil

⇒ No suppression of odd harmonics

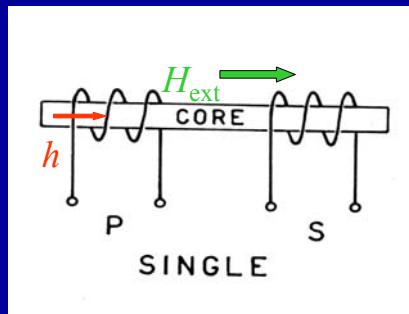

Fluxgate - Magnetometer (FGM)

Sensor Design:

Double Rod Core

Two individual excitation coils, common secondary coil

⇒ Only even harmonics

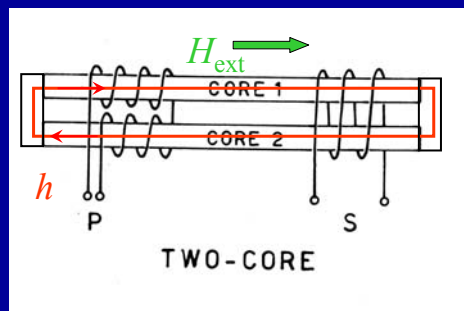

Fluxgate - Magnetometer (FGM)

Sensor Design:

Ring Core

Further development of the Double Rod Core with same advantages.

Common outer rectangular secondary coil

⇒ Only even harmonics

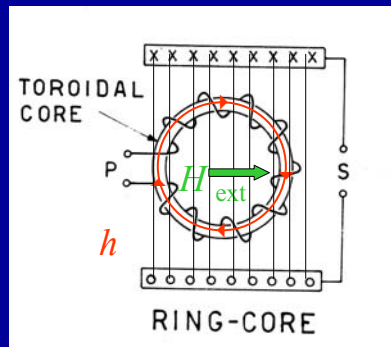

Fluxgate - Magnetometer (FGM)

Flux Distribution

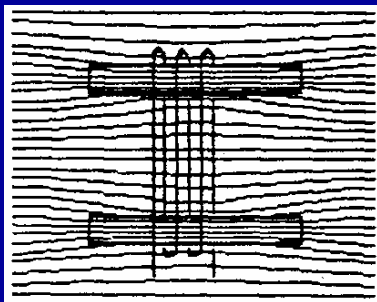

Double Rod Core

and

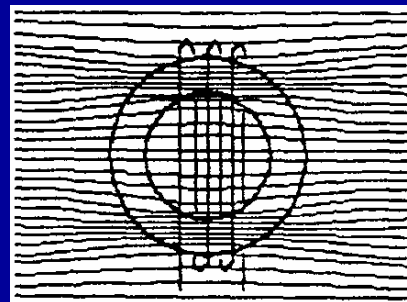

Ring Core

show equivalent flux distribution

Fluxgate - Magnetometer (FGM)

Examples

1- Axis Ring Core Sensor



Fluxgate - Magnetometer (FGM)

Examples

3 Axes FGM KTB Borehole Sensor

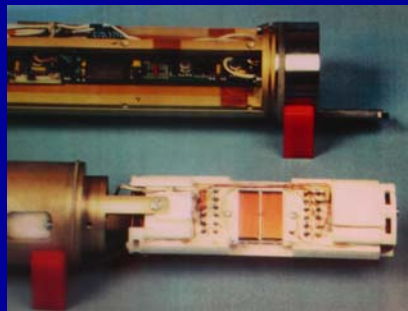
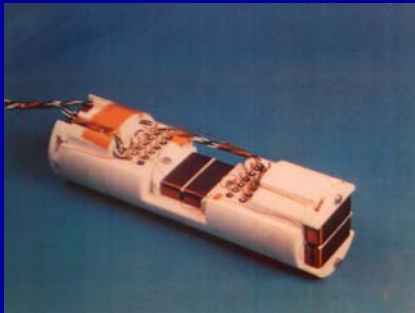

Fluxgate - Magnetometer (FGM)

Examples

3 Axes CLUSTER FGM Sensor

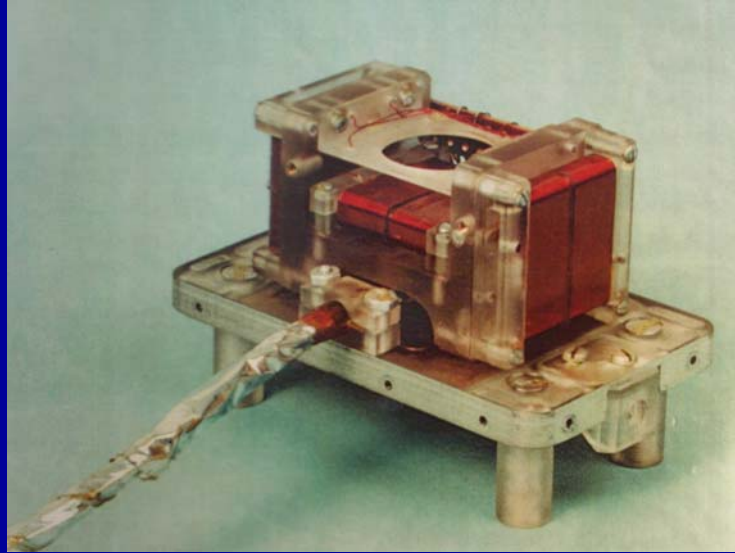

Fluxgate - Magnetometer (FGM)

Examples

3 Axes ROSETTA / DS 1 FGM Sensors

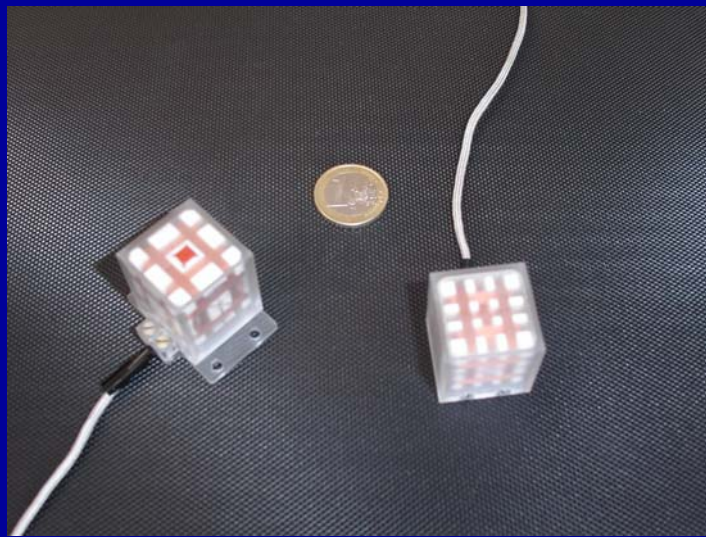

Fluxgate - Magnetometer (FGM)

Examples

DS 1 FGM Analog Electronics

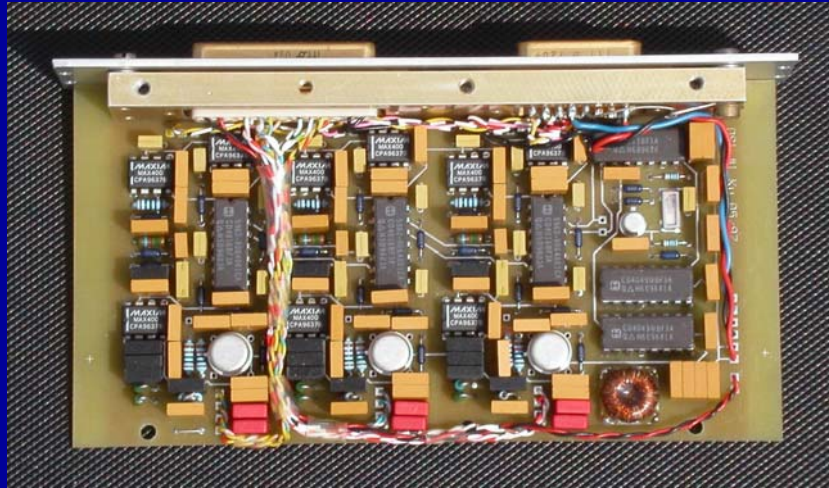

Fluxgate Magnetometer (FGM)

Characteristics

e.g. ROSETTA

Weight (sensor):	30 g
Power:	500 mW
Operating period:	15 years
Sampling:	20 vectors/s
Resolution:	0.04 nT
Dynamics range:	16000 nT

SearchCoil - Magnetometer Classification

- Induction-Coil-Magnetometer
 - ⇒ AC-field measurements only
- Frequency spectrum mHz ... MHz
- Vector measurements with 3 orthogonal coils

SearchCoil - Magnetometer Construction

- Sensor: Coil
- Electronics: Voltage measurement

SearchCoil - Magnetometer

Functional Principle

- Induction law: $\text{rot } \underline{E} = - d\underline{B} / d t$
- Induced Voltage: $U_{ind} = \int \underline{E} \cdot d\underline{s}$
 $\Rightarrow U_{ind} = - n d (F \cdot \underline{B}_{\perp}) / dt$
- Harmonic fields $B = \hat{B} \sin(\omega t)$ and constant area F
 $\Rightarrow \hat{U}_{ind} = n F \omega \hat{B}$

SearchCoil - Magnetometer

Characteristics

$$U_{ind} = n F \omega B$$

- Voltage rises linear with frequency & amplitude
- Signal in case of
 - * rotation of coil in constant field
 - * fixed coil in time varying field
 - * temporally varying coil geometry (Temperature!) in constant field

Result: Interpretation in unknown field is difficult if magnetometer (s/c!) is in motion

SearchCoil - Magnetometer

Real Sensors-Overview

Application	Axes	Wdgs.	Frequency Range [Hz]	Dimensions l x r [cm]	Sensitivity [$\mu\text{V}/\text{nT Hz}$]
Micro-pulsations	3	200000	1m ...10	200 x 1.25	700
Magneto-telluric (MT)	1	40000	0.3m... 300	120 x 1.15	73
Audio MT	1	10000	1 ... 20k	90 x 1.1	8.6
Helios S/C	1	60000	5 ...2.2k	35 x 0.3	6
Galileo S/C	1	1500	0.1 ... 100k	30 x 0.25	0.18

SearchCoil - Magnetometer

Example

Searchcoils onboard the Helios s/c

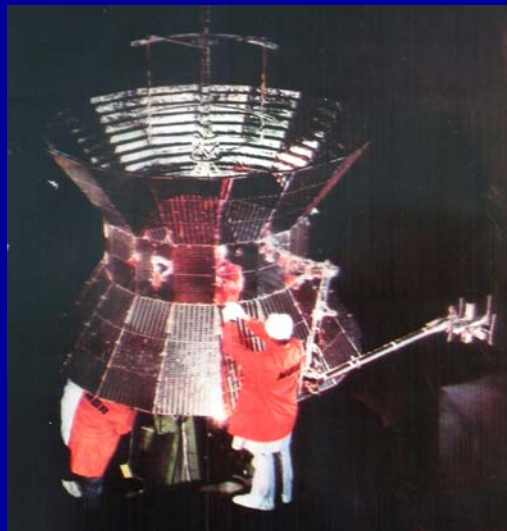

Magnetometer Calibration

Magnetometer Calibration Magnetsrode - MCF

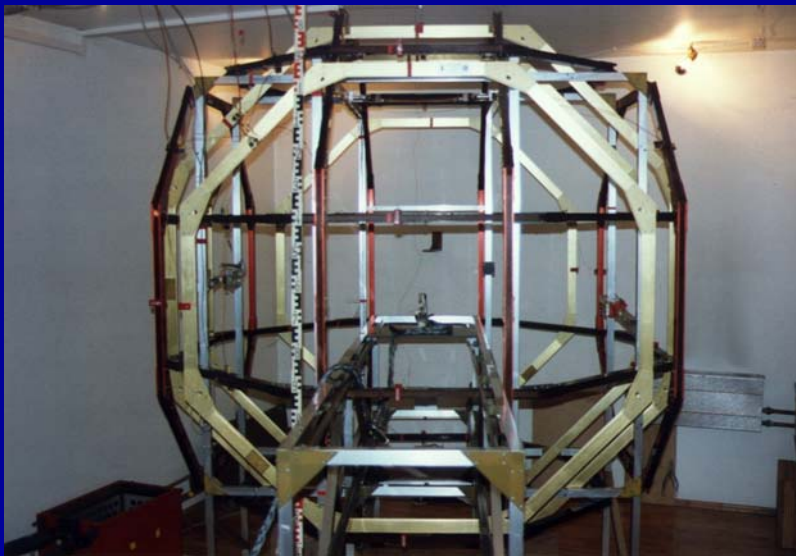

Magnetometer Calibration

Magnetsrode - Characteristics

- Compensation: Dynamic
- Field - Range: -100000 nT ... +100000 nT
- Field - Direction: any, 3 components
- Field - Type : DC, AC, Arbitrary
- Field - Sequence: arbitrary, user defined
- Accuracy: < 0.8 nT

Magnetometer Calibration

Sensor Model

$$\underline{B}_c = \underline{F}^{-1} \underline{B}_m$$

$$\underline{B}_c = \{ \underline{R}^{-1} \quad \underline{M}^{-1} \quad \underline{S}^{-1} \} (\underline{B}_r - \underline{B}_o - \underline{B}_{res})$$

Magnetometer Calibration Parameters

- Sensitivity $\underline{S} = \{S_{ii}\}, \quad S_{ii} = S_{ii}(T)$
- Misalignment $\underline{M} = \{M_{ij}\}, \quad M_{ij} = M_{ij}(T)$
- Offset $\underline{B}_O = \{B_{ox}(T), B_{oy}(T), B_{oz}(T)\}$
- Frequency Response

Magnetometer Calibration Parameters - Sensitivity

$$(S_{ii})^{-1} = \sigma_{0,i} + \sigma_{1,i} \cdot T$$

$\sigma_{0,x}$ [1]	$\sigma_{0,y}$ [1]	$\sigma_{0,z}$ [1]
1.09070	1.09434	1.09413

ROSETTA:

$\sigma_{1,x}$ [1/K]	$\sigma_{1,y}$ [1/K]	$\sigma_{1,z}$ [1/K]
-1.42E-005	-9.30E-006	-8.55E-006

Magnetometer Calibration Parameters - Misalignment

$$(\underline{\underline{M}})^{-1}(T) = \begin{pmatrix} 1 & \cos(\xi_{xy}(T)) & \cos(\xi_{xz}(T)) \\ 0 & \sin(\xi_{xy}(T)) & \frac{\cos(\xi_{yz}(T)) - \cos(\xi_{xy}(T)) \cdot \cos(\xi_{xz}(T))}{\sin(\xi_{xy}(T))} \\ 0 & 0 & \sqrt{\sin^2(\xi_{xz}(T)) - ((\underline{\underline{M}})^{-1}_{12})^2} \end{pmatrix}$$

$$\xi_{ij}^1(T) = \xi_{0,ij} + \xi_{1,ij} \cdot T$$

ROSETTA:

$\xi_{0,xy} [^\circ]$	$\xi_{0,xz} [^\circ]$	$\xi_{0,yz} [^\circ]$
90.0348	89.9587	89.9433

$\xi_{1,xy} [^\circ/\text{K}]$	$\xi_{1,xz} [^\circ/\text{K}]$	$\xi_{1,yz} [^\circ/\text{K}]$
8.54E-005	3.71E-005	1.20E-004

Magnetic Cleanliness

Magnetic Cleanliness

Basic Ideas

- Magnetic properties of the s/c have to be known to perform excellent measurements in space
 - ⇒ Every unit has to be mapped before integration
- S/C is represented by a model of n Dipoles
- Usage of Compensation-Magnets
 - ⇒ Magnetic field at the location of the MAG can be minimized

Magnetic Cleanliness

A mobile Coil Facility - (MCF)

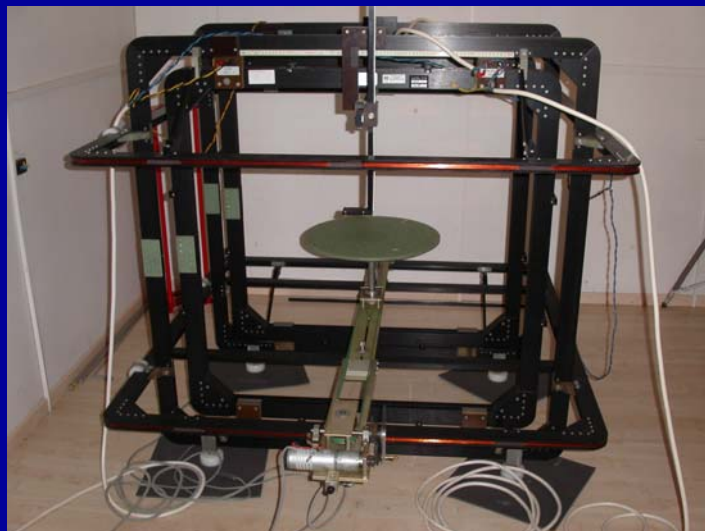

Magnetic Cleanliness

Example: A CLUSTER Thruster

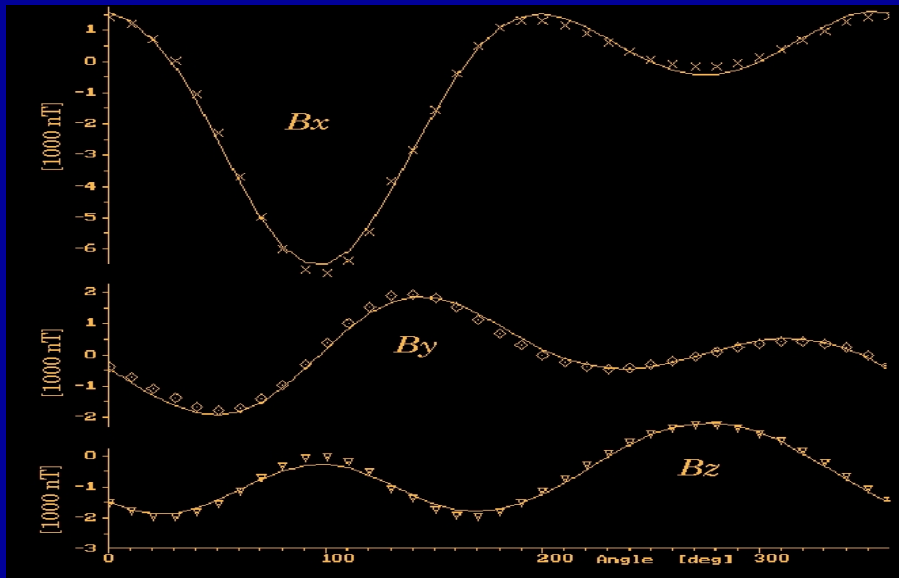

Magnetic Cleanliness

Example: A CLUSTER Thruster

REPORT (UNIT LEVEL MODEL)

DUT-NAME: 10 Newton Thruster s/n 485

SCS (Spacecraft Coordinate System)

	Position [cm]			Moments [mAm ²]			Mtot
	x	y	z	Mx	My	Mz	
1.	22.18	112.21	85.48	327.53	-384.85	-16.20	505.62
2.	28.47	100.32	86.69	-1105.86	-2189.66	334.80	2475.80
3.	25.90	101.97	86.78	729.64	2505.89	-276.60	2624.57

Total Moment spec: 9.50

Total Moment : -48.68 -68.62 42.00 94.03

Pos FGMO (x,y,z) [cm] : 124.65 -600.19 52.59

Field FGMO spec (x,y,z,tot) [pT]: -0.7 5.2 0.3 5.3

Field FGMO (x,y,z,tot) [pT]: 23.1 -33.0 -14.4 42.8

Summary

- Magnetic field measurements in space are exciting and interesting due to complex, temporally varying plasma interactions between SW, celestial bodies
- Instrumentation: FGM is standard s/c application (low power, lightweight, reliable, remote controlled, radiation hard, long term stable, high resolution...)
- Careful calibration necessary for serious science
- Extensive Magnetic Cleanliness program guarantees known measurement conditions

More Information:



- **Modern Magnetic Field Measurement Devices:**
ftp://geophys.nat.tu-bs.de/pub/mrode/doc/mag_en_over.pdf
- **Daily Magnetic Field Data:**
www.geophys.tu-bs.de/dienste/mrode/daten_en.html
- **Magnetsrode Calibration Facility:**
www.geophys.tu-bs.de/dienste/mrode/magnetsrode_en.html